

ELECTRONIC COMPONENTS & DEVICES

製品 PRODUCTS

カタログNo./CAT.No.

アルミ電解コンデンサ Aluminum Electrolytic Capacitors	1001
積層セラミックコンデンサ Multilayer Ceramic Capacitors	1002
フィルムコンデンサ Film Capacitors	1003
セラミックバリスタTNR™ Metal Oxide Varistors TNR™	1006
ナノ結晶合金/アモルファス/ダスト チョークコイル Nanocrystalline / Amorphous / Dust Choke Coils	1008
電気二重層キャパシタ Electric Double Layer Capacitors	1009
カメラモジュール Camera Modules	



2020 ▶ 2021



安全に関するご注意/Notes on Safety

- 製品を正しく安全にご利用していただき、トラブルや事故などを未然に防いでいただくため、ご使用前に必ず「使用上の注意事項」をよくお読みください。
- ご注文の際は当社の「納入仕様書」をご要求いただき、本カタログと合わせてご覧ください。各製品に個別の「使用上の注意事項」を記載する場合があります。
- このカタログに記載の製品は一般電子機器用に設計・製造されたものであり、人命に関わる用途・機器の故障・誤動作・不具合が人への生命や財産に損害を及ぼす恐れがある用途、または、社会的に大きな影響を与える恐れがある以下の様な特定用途で使用される場合、事前に当社窓口まで相談を頂き協議の上ご使用願います。
 - ①航空・宇宙機器 ②原子力機器 ③医療用機器 ④輸送用機器(自動車、列車、船舶等) ⑤交通機関制御機器 ⑥防災・防犯機器 ⑦公共性の高い情報処理機器 ⑧海底機器 ⑨その他特定用途と考えられる機器
- このカタログや「納入仕様書」などに例として記載された回路は、当社製品の動作例・利用例を説明するために記載されたもので、実際にお客様が使用する機器システムにおける動作利用の可能性を保障するものではありません。これらの情報の使用に起因する故障・損害について、当社は一切の責任を負いかねますのでご了承ください。「納入仕様書」などに記載された特性を有する当社製品が、お客様の機器システムでの仕様に適しているかを確認し、判断するのはお客様であり、最終的にお客様の責任となります。万が一、当社製品が故障しても人身事故、火災事故などを生じさせないよう、お客様自身で冗長設計、誤動作防止設計などの安全設計をお願いいたします。
- Always read "Notes on Use" before using the product in order to enable you to use the product correctly and prevent any faults and accidents from occurring.
- Request the Product Specification on the product of NIPPON CHEMI-CON CORPORATION to refer to it as well as this brochure prior to the order of the products. Some specific notes on use of the ordered product may be described in the specifications.
- The products listed in this catalog are designed and manufactured for general electronics equipment use and are not intended for use in applications that can adversely affect human life; where the malfunction of equipment may cause damage to life or property. In addition, our products are not intended to be used in specific applications that may cause a major social impact. Please consult with us in advance of usage of our products in the following listed applications. ① Aerospace equipment ② Power generation equipment such as thermal power, nuclear power etc. ③ Medical equipment ④ Transport equipment (automobiles, trains, ships, etc.) ⑤ Transportation control equipment ⑥ Disaster prevention / crime prevention equipment ⑦ Highly publicized information processing equipment ⑧ Submarine equipment ⑨ Other applications that are not considered general-purpose applications.
- The circuits described as examples in this catalog and the "delivery specifications" are featured in order to show the operations and usage of our products, however, this fact does not guarantee that the circuits are available to function in your equipment systems. We are not in any case responsible for any failures or damage caused by the use of information contained herein. You should examine our products, of which the characteristics are described in the "delivery specifications" and other documents, and determine whether or not our products suit your requirements according to the specifications of your equipment systems. Therefore, you bear final responsibility regarding the use of our products. Please make sure that you take appropriate safety measures such as use of redundant design and malfunction prevention measures in order to prevent fatal accidents and/or fires in the event any of our products malfunction.

ご注意/Note

- 当社の製品を購入される際には、「日本ケミコン株式会社の正規販売網」であることを確認された上でご購入ください。正規販売網以外から購入した製品や、模倣品を使用したことに基づく不具合・損害につきましては、当社はその責任を負いかねます。尚、正規販売網以外で購入された製品に対する調査費用はお客様にてご負担をお願いします。
- 当社は製品の製造および納入を取りやめる権利を留保します。このカタログに含まれているすべての製品が、永続的に入手可能であることを当社は保証するものではありません。尚、お客様用の特定製品について前記内容と異なる取り決めが個別に交わされた場合には、この限りではありません。
- 当社は品質、信頼性の向上に努めておりますが、万が一、製品が納入仕様書に適合しない場合には速やかに使用を中止し、当社にお問い合わせください。尚、補償に関しては納入仕様書に適合しない場合に限らせて頂き、代替品の無償提供あるいは販売金額を上限とさせていただきます。また、当社ではトレーサビリティが取れるシステムを構築しておりますので、対象は該当ロット品限定とさせていただきます。
- 当カタログの記載内容は2020年4月現在のものです。
- We strongly recommend our customers to purchase Nippon Chemi-Con products only through our official sales channels. We assume no responsibility for any defects or damages caused by using products purchased from outside our official sales channel or of counterfeit goods. In addition, we will ask the customer to pay the investigation cost for products purchased outside our official sales channel.
- We reserve the right to discontinue production and delivery of products. We do not guarantee that all the products included in this catalog will be available in the future. The aforementioned does not apply in the case of individual agreements deviating from the foregoing for customer-specific products.
- We continually strive to improve the quality and reliability of our products, but in any case that our product does not meet our published specifications, please stop using it promptly and contact us immediately. As for compensation for non-conforming goods delivered by Chemi-Con, we will limit it only to goods found in non-compliance of our published specifications. This may be accomplished by a no cost replacement of non-conforming individual products, a credit of the piece price paid per each individual non-conforming product, or in other ways deemed necessary. In addition, we have an established system with enhanced traceability, therefore we will limit the applicable lot items for any potential compensation.
- The content of this catalog is as of April 2020

Solutions for Automotive Electronics

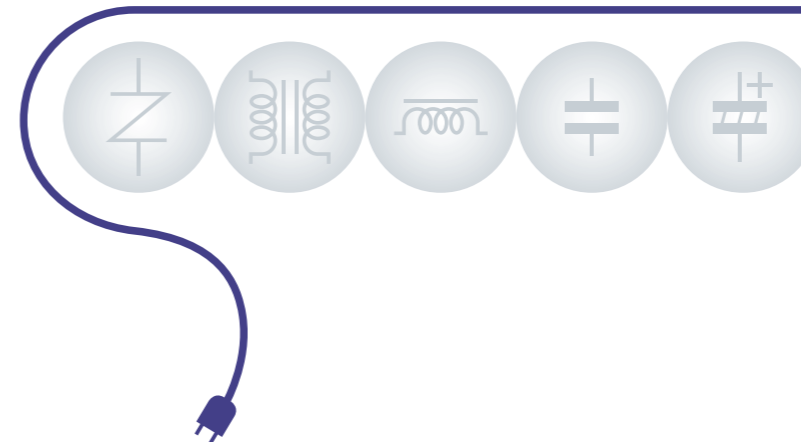

日本ケミコン株式会社
NIPPON CHEMI-CON CORPORATION
<http://www.chemi-con.co.jp/>



特約店 / Distributed or Represented by /

環境と人にやさしい技術への貢献

モビリティの進化に磨かれた信頼のパートナー

Contributing to Environmentally and People Friendly Technology
Reliable partner refined by evolution of mobility

日本ケミコンは100年に一度の変革期を迎える自動車業界に『信頼』と『安全』のカーエレクトロニクスをお届けいたします。

当社製品は、電気自動車やプラグインハイブリッド車向けオンボードチャージャー(車載充電器)など、xEV車に搭載される機器のほか、エンジンやステアリングを制御するための電子回路やSRSエアバッグ、エアコン、ヘッドライトなど幅広い電装機器に使われています。特に近年は、ADAS(先進運転支援システム)や自動運転技術、システム電圧の48V化に関する需要が拡大しています。

の貢献

パートナー

Technology

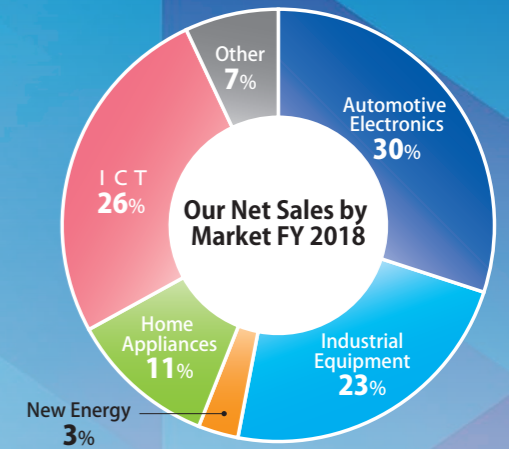

Nippon Chemi-Con Corporation gives car electronics with reliability and safety to automotive industry forward a once-in-a-century reform.

In addition to xEV electronics such as on-board chargers for EVs and plug-in hybrids, our products are also used in the electronic circuits that control engines and steering as well as a wide variety of other vehicle electronics including SRS airbags, air conditioners, and headlights. In recent years, we are seeing increased demand related to advanced driving assistant systems (ADAS), autonomous driving technology, and 48V system voltage conversion.

注力の技術領域と新商品のご紹介

Our Focusing Business Area and Our Latest New Products for Automotive Electronics Market

導電性高分子テクノロジー領域

Conductive polymer technology Domain

PXN series



SMD 導電性高分子
アルミ固体電解コンデンサ
NPCAP™
SMD Conductive Polymer
Aluminum Solid Capacitors
NPCAP™

HXE series



SMD 導電性高分子
ハイブリッドアルミ電解コンデンサ
SMD Conductive Polymer Hybrid
Aluminum Electrolytic Capacitors

HSF series



THD 導電性高分子
ハイブリッドアルミ電解コンデンサ
THD Conductive Polymer Hybrid
Aluminum Electrolytic Capacitors

パワーエレクトロニクス・テクノロジー領域(磁性体、セラミック)

Power Electronics Components Business Domain (Magnetic & Ceramic Materials)

FL-V series

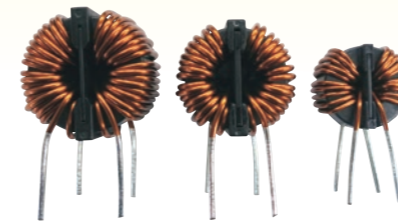

ナノ結晶合金
コモンモードチョークコイル
Nanocrystalline
Common Mode Choke Coils

SV series

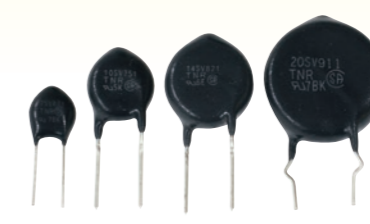

ディスク形不燃バリスタ TNR™
Metal Oxide Varistors TNR™
Non flammable and Little Scatter Type

NTJ series



金属キャップタイプ
SMD積層セラミックコンデンサ
Metal Cap Type
Multilayer Ceramic Capacitors

電解液テクノロジー領域

Electrolyte technology Domain

MHS series



SMD アルミ電解コンデンサ
SMD Aluminum Electrolytic Capacitors

LBV series



THD アルミ電解コンデンサ
THD Aluminum Electrolytic Capacitors

DKA series

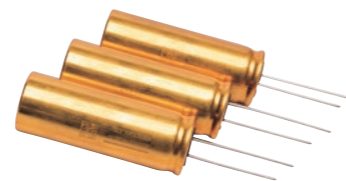

THD 電気二重層キャパシタ
DLCAP™
THD Electric Double Layer Capacitors
DLCAP™

各種機能モジュール領域

Various functional module technology Business Domain

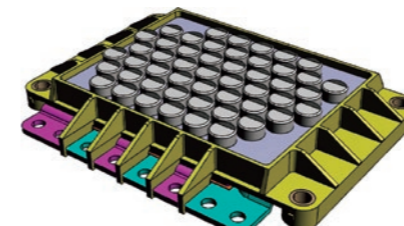

LC モジュール(コイル、コンデンサ)
Passive Components LC Modular Technology



電気二重層キャパシタ・モジュール
Electric Double Layer Capacitors
Modular Technology



CMOSカメラモジュール
CMOS Camera Modular Technology

LC-Modules

日本ケミコン株式会社は、コンデンササプライヤだからこそ可能な受動モジュールの電気設計、熱設計、構造設計のトータルソリューションをご提供致します。

Nippon Chemi-Con Corporation, provides total solutions of electrical design, thermal design and structural design of passive modules.

当社LCモジュールの強み Advantages of our LC module

豊富な部品ラインナップ Abundant product lineup

▶コンデンサ、コイル、バリスタなど多種多様な部品を取り揃えています。

We have a great selection of electronic devices

モジュール案件実績 Experience

▶すでに車載、産業機器向けのLCモジュールの提案実績、採用実績があります。

We have already succeeded modularization for car and industrial equipment

要素技術 Elemental technology

▶溶接技術やCAE解析技術を開発中です。

We are developing elemental technology in welding and in CAE analysis

一貫した品質保証 Consistent quality assurance

▶ホルダも含めLCモジュールとしての品質を保証します。

We can guarantee quality of module including holder

Introductory

横型汎用コンデンサホルダ Horizontal Generic Capacitor Holder

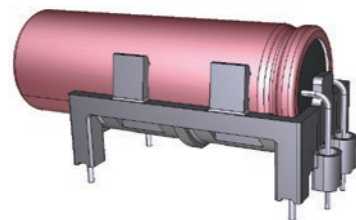

- Provide in the holder built-in state
- Over 30L size available (Only φ18)
- Mounting density improvement by using the space under the holder
- Long-life by easing the heat from the board
- Fix by flow soldering and non-glue

◆ Dimension

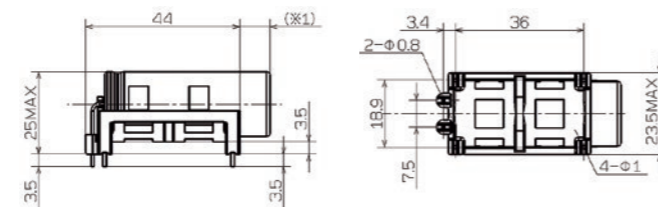

L dimension	(※1) Length
30	0
35.5	0.5MAX
40	5MAX
45	10MAX
50	15MAX

Introductory

縦型耐振動コンデンサホルダ Vertical vibration-Resistant Capacitor Holder

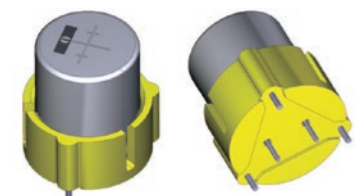

- Dimension of capacitor (φ18 × 20L)
- Resonance characteristics improvement by holder

◆ Resonance characteristics with our evaluation board

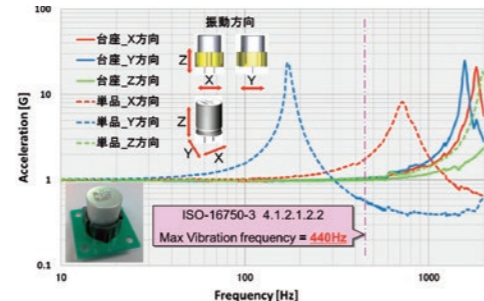

◆ Dimension

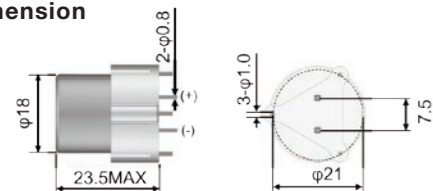

車載向け 48V DCリンク モジュール 48V DC-Link Module for Automotive

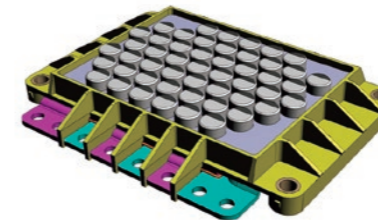

- 48V EV/HEV向けDCリンクモジュール
- 電流/熱バランス設計
- 低インダクタンス設計
- 耐振動/耐衝撃/冷却構造
- モジュール漏れ電流を規定
- モジュール寿命保証

- 48V DC-Link Module for EV / EHV
- Design for Current / Thermal Balance
- Low Inductance Design
- Vibration / Impact-Resistance and Cooling Structure
- Specify Leakage-Current of Module
- Module-life Guarantee

◆ Dimension

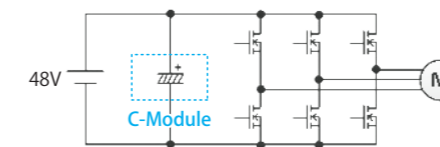

車載向け オンボードチャージャー モジュール On-board Charger Module for Automotive

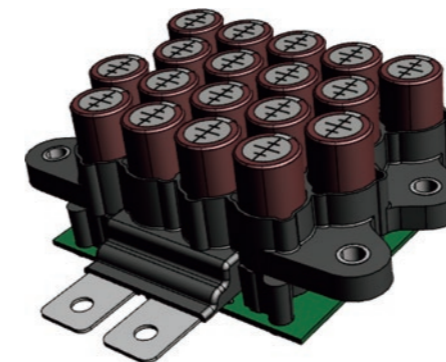

- EV/HEV向けOBCモジュール
- 耐振動/耐衝撃/冷却構造
- 高電圧絶縁設計
- EOL 静電容量/モジュール寿命保証

- On-Board Charger Module for EV / EHV
- Vibration / Impact-Resistance and Cooling Structure
- Design for High Voltage Insulation
- Capacitance End-of-Life and Module-Life Guarantee

◆ Dimension

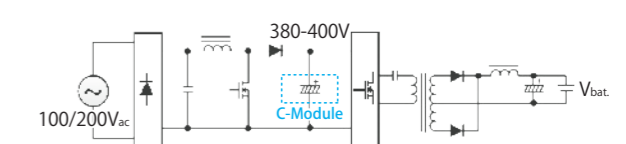

CAE解析技術 CAE Analysis Technology

- 構造/熱解析により、耐振動性や発熱を予測し、最適化を行います。
- These simulation make it possible to predict heat and vibration resistance and optimize them

構造解析
Mechanical simulation

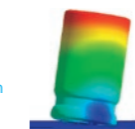

熱解析
Thermal simulation

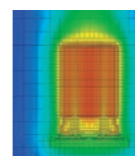

モジュール要素最適化 Optimize Module Element

- 部品の温度上昇抑制や低インダクタンスを実現します。
- These elemental technology enables suppress temperature rise of parts and make inductance low



低インダクタンス構造
Low Inductance structure

溶接技術 Welding Technology

- 自由度の高い接続/組み立てを実現します。
- Flexible connection / assembly is possible.

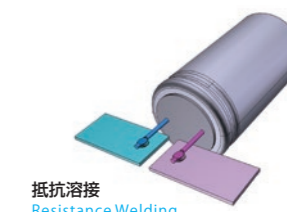
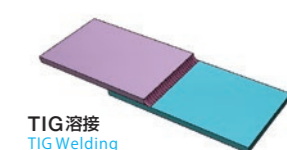

抵抗溶接
Resistance Welding

スルーホールリフロー対応品の実現と高音質化(D.R.A.S.)への取り組み

I スルーホールリフロー工法とは?

リード部品のリフロー化により、フローはんだ付け工程を削除!
Cut the flow process by reflowing lead parts

I スルーホールリフロー工法の概要

process 面実装品と同じ実装方法 Same process of SMD type

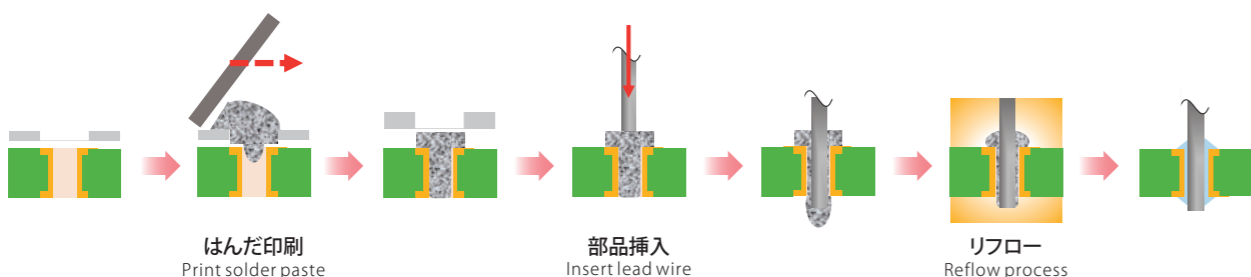

I スルーホールリフロー工法対応品のご提案例

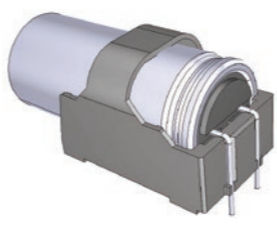
Type	Vertical type	Horizontal type
Appearance	 Mass production	 Introductory
Size (mm)	Capacitor : $\phi 12.5 \times 20L$ Height : Max23 (Exclude terminals) Cap terminals : $\phi 0.8 \times 2$ With Dummy terminals	Capacitor : $\phi 18 \times 40L$ Height : Max25 (Exclude terminals) Cap terminals : $\phi 0.8 \times 2$ Dummy terminals : $\phi 1.0 \times 1$
Reflow Recommended Conditions	Peak: Max240°C Over 230°C : Max. 20sec. Over 217°C : Max. 30sec. 150~180°C : Max. 120sec. 2 times Measurement point : Case top and soldering part	←
Holder Material	PA9T-GF35	PA9T-GF35
Characteristic	<ul style="list-style-type: none"> 端子リード位置管理値 : $\phi 0.5$ 専用トレイ出荷 (自動実装対応) はんだ接合面積が大きく、面実装品より機械的強度に優れる。 面実装品と同等の耐振性能。 Terminal position : $\phi 0.5$ Exclusive tray (for automatic mounting) soldering area is larger and better mechanical strength than SMD type Same level resistance of SMD type 	<ul style="list-style-type: none"> コンデンサ寸法 : $\phi 18 \times 25L \sim 40L$ チップ形アルミ電解コンデンサ ($\phi 18 \times 21.5L$品)と同じ製品高さ。 横置き構造ではんだ溶融性改善。 裏面補助端子により耐振性向上。 for $\phi 18 \times 25L \sim 40L$ size capacitor Same height of SMD 21.5L type Exposed portion is wide and solder is easy to melt vibration resistance improvement by dummy terminal

Horizontal typeの製品は開発段階であり、量産化は決定していません。上記仕様は予告なしに変更される場合があります。
Horizontal type is under development and not being mass produced. The specifications are subject to change without notice.

Capacitor for Through Hole Reflow and efforts for high quality sound (D.R.A.S.)

I 高音質化(D.R.A.S.)への取り組み

次世代の車載オーディオ用途に特化させた高音質アルミ電解コンデンサを開発
ハイレゾリソース音源に最適な音像表現力を複合的に実現した
この圧倒的【DRASTIC】なテクノロジーに「D.R.A.S.」と名付けた

Nippon Chemi-Con corporation developed the capacitor for car audio which has excellent sound quality.
we call this drastic technology D.R.A.S. that complexly realizes sound image for high-Resolution Audio.

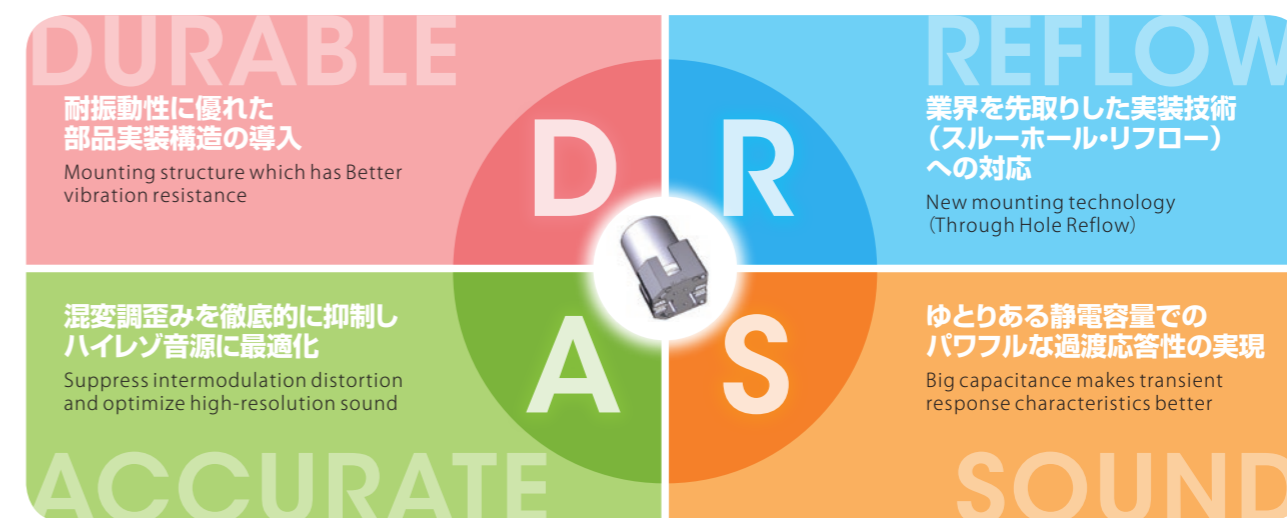

◆ コンデンサの周波数特性 F-Z frequency response

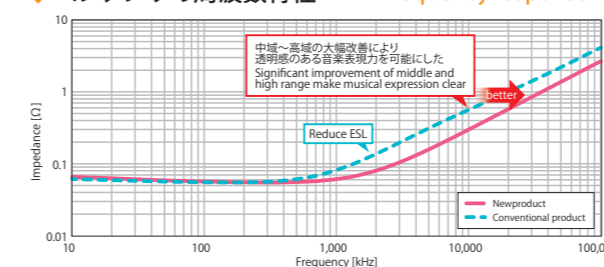

◆ 過渡応答特性 transient response characteristics

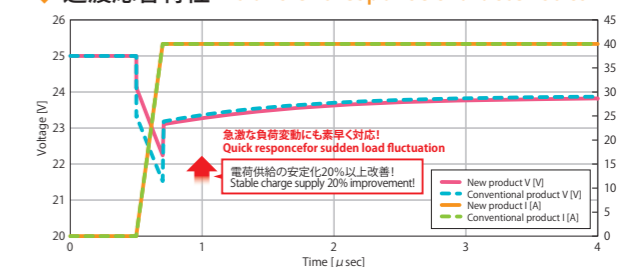

- 大音量時に発生する急激な負荷変動時でも電荷の安定供給が実現 (20%以上改善)
- 電荷の安定とESLを低減する事で音揺れや高調波ノイズを抑制 ⇒ Accurate Soundの誕生
- Even when load fluctuation happens by high volume, charge supply is stable (20% improvement)
- stable charge and low ESL suppress harmonic noise and sound vibration ⇒ Accurate Sound



オーディオ用アルミ電解コンデンサのシステム商標

帯域バランスが良く、潤いに優れ、ナチュラルな音の追求
Pursuit of Pleasant, natural and well-balanced sound.

MAK series

アルミ電解コンデンサ (チップ形)
Aluminum Electrolytic Capacitors (SMD type)

- Rated voltage range : 6.3~50V
- Capacitance range : 1.0~330 μF
- Case size : $\phi 4 \times 5.2L \sim \phi 8 \times 6.3L$

MAR series

アルミ電解コンデンサ (チップ形)
Aluminum Electrolytic Capacitors (SMD type)

- Rated voltage range : 6.3~50V
- Capacitance range : 22~1000 μF
- Case size : $\phi 8 \times 6.3L \sim \phi 10 \times 10L$



LC-Filter

アモルファスSMコイルとハイブリッドコンデンサの組合せによるソリューションを紹介します

Solution by combination of Amorphous SM coil and Hybrid Capacitor

日本ケミコンのアルミ電解コンデンサ技術と、アモルファスコイル技術を用いた車載向けLCフィルタの特性評価結果をご紹介します。

Nippon Chemi-Con Corporation, shows the evaluation result of LC Filter for Automotive used Hybrid Capacitor and Amorphous coil.

LCフィルタ(ローパスフィルタ) LC Filter (Low Pass Filter)

- ▶ LCフィルタ(ローパスフィルタ)は直流電源ラインに挿入し、不要な高調波ノイズを除去します。
LC Filter (Low Pass Filter) inserted DC line can eliminate harmonic noise.

◆ LCフィルタ(ローパスフィルタ)回路図 Circuit

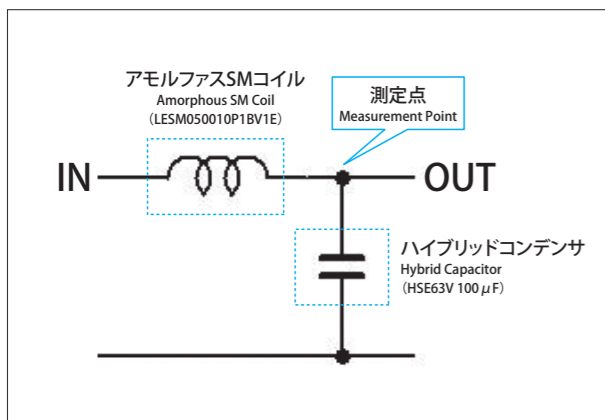

◆ LCフィルタ外観図 Appearance

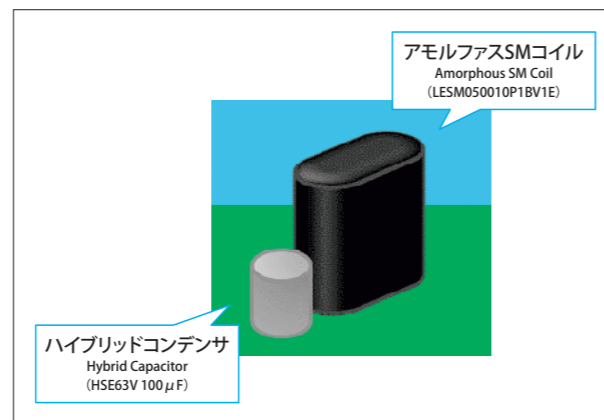

◆ 測定点の減衰特性 Attenuation Characteristic of Measurement Point

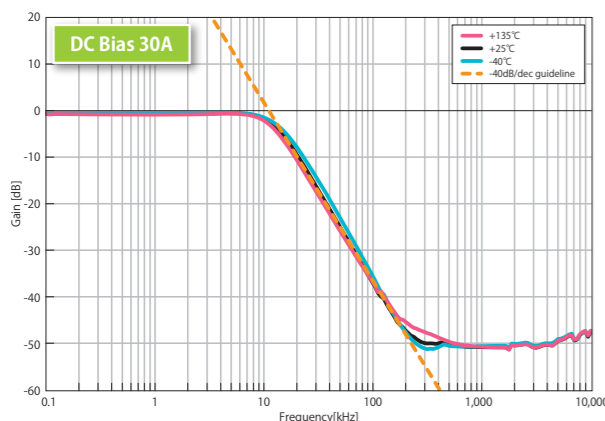

- ▶▶▶ 直流電流重畳特性が良好です。
Excellent DC bias characteristics
 - ▶▶▶ 理想的な減衰特性が得られます。
Perfect Attenuation characteristics
 - ▶▶▶ 温度依存が小さい特性を持ちます。
Low Temperature dependence
- 次ページの要素の複合効果によりこれらの特性は達成されます。
These characteristics are achieved by compound effect of following factors.

要素1 直流重畳特性 DC bias characteristics

- ▶ アモルファスSMコイルは電流依存性が少なく、直流電流値によるインダクタンス変化が小さい特性を持ちます。
Amorphous SM coil has low Current dependence and low Inductance change by DC value.
- ▶ 大きな直流電流が流れる回路では、従来のトロイダルコイルとSMコイルのインダクタンス差は殆どありません。
There is less Inductance difference between Toroidal coil and SM coil in circuit where a large DC current flows.

◆ コイルの電流重畳特性 DC bias characteristics

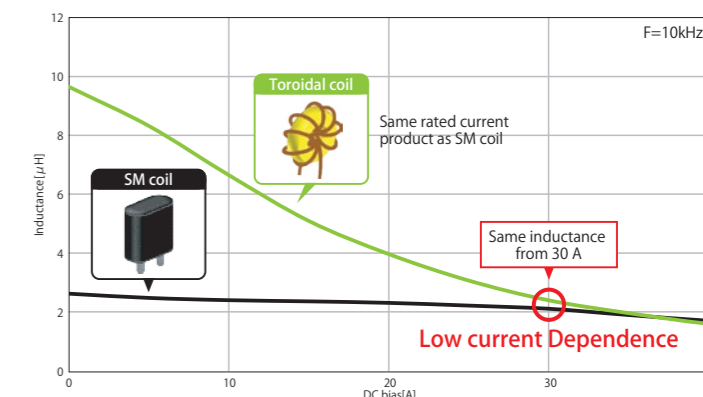

要素2 低電力ロス、低発熱 Low Power Loss, Low fever

- ▶ アモルファスSMコイルは直流抵抗(DCR)が小さく低電力ロスで低発熱です。
Amorphous SM coil has low DCR, low Power loss and low fever.

◆ コイルの発熱特性 Heating Characteristics

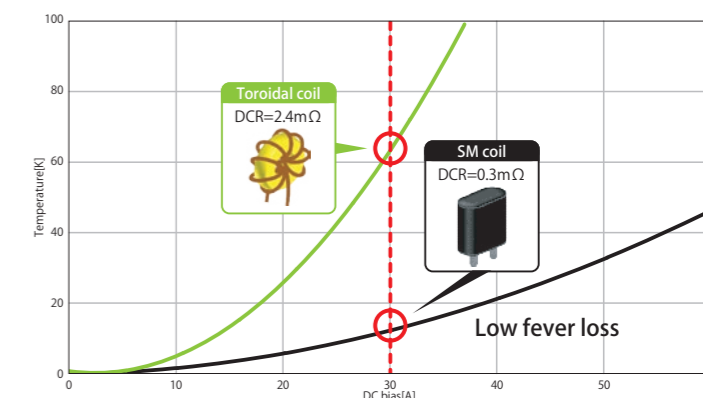

要素3 温度依存性 Temperature dependence

- ▶ アモルファスSMコイル及びハイブリッドコンデンサは温度依存が少ない特性を持ちます。

Amorphous SM coil and Hybrid Capacitor have low Temperature dependence.

※またハイブリッドコンデンサはESRが低く、約200kHzまでコンデンサ機能が維持できます。
Hybrid Capacitor has low ESR and it maintains capacitor function until about 200kHz.

◆ ハイブリッドコンデンサ Z,ESR温度特性 Hybrid Capacitor Temperature Characteristics

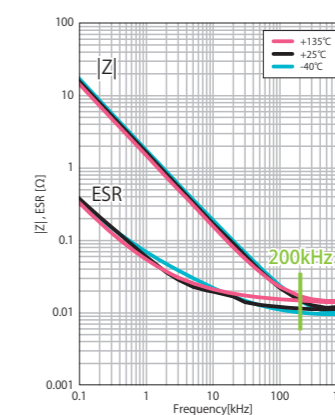

◆ SMコイル インダクタンス温度特性 Amorphous SM coil Temperature Characteristics

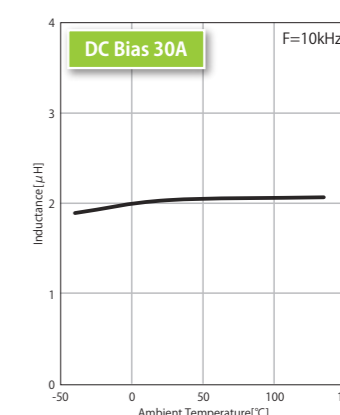

Category Max Temp.
125°C

アルミ電解コンデンサ

Aluminum Electrolytic Capacitors

MHU series

Introductory

製品形状 Product Shape	チップ形 Surface Mount Type	
開発テーマ Development Theme	高温度125°C長寿命・高耐振動品の開発 Development of High Vibration Resistance and Long Life Products at high temperature 125°C	
開発の背景 Background of the Development	機電一体形のECUやxEVの駆動インバータの制御回路に最適 For Electromechanical Integration ECU and Driving Inverter	
お客様のベネフィット Customer's Benefits	① 125°C 5,000時間保証 Endurance: 5,000 hours at 125°C	
	② 耐震台座との組み合わせで振動加速度40G対応 Supports 40G vibration acceleration condition in combination with vibration resistant structure	
	③ 高温リフロー対応 Available for high temperature reflow soldering	
対象機能 Target ECU Function/Application	① エンジンECUやトランスミッション系ECUの電源回路 For ECU and Transmission ECU	
	② 電動ポンプ系コントローラの電源回路 For Electronic Pump Controller	
	③ xEV系駆動インバータの制御回路 For xEV Driving Inverter	
開発スケジュール Development Schedule	サンプル:お問い合わせください / Sample: Please contact us	量産:お問い合わせください / Mass Production: Please contact us
AEC-Q200 Compliant	AEC-Q200に準拠します。詳細については別途お問い合わせください AEC-Q200 compliant: Please contact Chemi-Con for more details, test data, information	



◆ Features

- By adopting a new composite sealing structure, the amount of electrolyte evaporation has been reduced by 40% or more compared with conventional product and 2.5 times longer life has been achieved
- Supports 40G vibration acceleration condition in combination with vibration resistant structure

◆ Standard ratings

WV (Vdc)	Cap (μF)	Size Code	tan δ	ESR (Ω max./100kHz)		Rated ripple current (mA _{RMS} /125°C, 100kHz)
				20°C	-40°C	
35	330	JA0	0.14	0.2	3.0	330

◆ Recommended soldering heat conditions

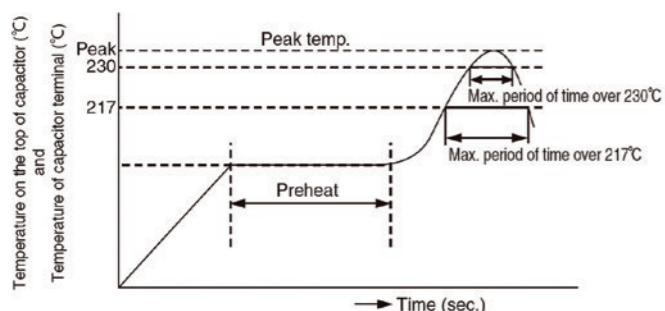

Preheat	Time maintained above 217°C	Time maintained above 230°C	Peak temp.	Reflow number
150 to 180°C 120sec. max.	90sec. max.	60sec. max.	260°C max.	1 time
150 to 180°C 120sec. max.	60sec. max.	30sec. max.	245°C max.	2 times or less

Category Max Temp.
125°C

アルミ電解コンデンサ

Aluminum Electrolytic Capacitors

MHS series

Introductory

製品形状 Product Shape	チップ形 Surface Mount Type	
開発テーマ Development Theme	125°C長寿命品の開発 Development of 125°C Long Life Products	
開発の背景 Background of the Development	各種ECUの電源回路に最適 For Various ECU	
お客様のベネフィット Customer's Benefits	① 125°C 3,000/5,000時間保証 Endurance: 3,000 or 5,000 hours at 125°C	
	② MVHシリーズを高容量化 Higher capacitance than MVH series	
	③ 高温リフロー対応 Available for high temperature reflow soldering	
対象機能 Target ECU Function/Application	① 各種ADAS用レーダー、LiDARの電源回路 For ADAS Rader and LiDAR	
	② 各種カメラ系ECUの電源回路 For Camera ECU	
	③ エンジン室搭載の各種ECUの電源回路 For Various ECU in Engine Room	
開発スケジュール Development Schedule	サンプル (HA0, JA0): お問い合わせください / Sample (HA0, JA0): Please contact us サンプル: 対応中 / Sample: Ongoing	量産 (HA0, JA0): お問い合わせください / Mass Production (HA0, JA0): Please contact us 量産: 対応中 / Mass Production: Ongoing
AEC-Q200 Compliant	AEC-Q200に準拠します。詳細については別途お問い合わせください AEC-Q200 compliant: Please contact Chemi-Con for more details, test data, information	



◆ Features

- Downsizing, High capacitance
- High temperature reflow soldering
- Solvent resistant type
- RoHS2 Compliant
- Endurance: 125°C 3,000 to 5,000 hours
- Voltage: 16 ~ 100V
- Cap: 62~6,200μF
- Size: φ8×10L~φ18×21.5L

◆ Capacitance comparison

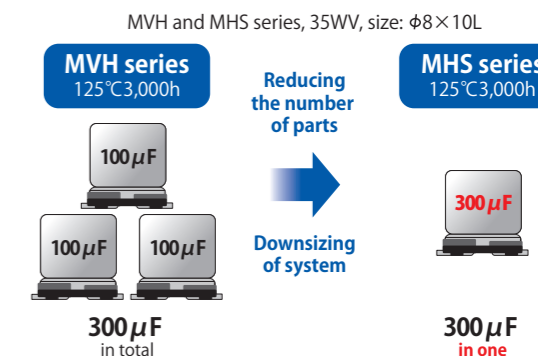

◆ Standard ratings of newly added items (HA0, JA0 size)

WV (Vdc)	Cap (μF)	Size code	ESR (Ω max./100kHz)		Rated ripple current (mA _{RMS} /125°C, 100kHz)
			20°C	-40°C	
16	680	HA0	0.19	3.1	540
	1,100	JA0	0.12	1.8	670
25	470	HA0	0.18	3.0	550
	750	JA0	0.12	1.7	680
35	300	HA0	0.18	3.0	550
	470	JA0	0.12	1.7	680
50	150	HA0	0.39	5.2	430
	240	JA0	0.23	3.0	530
63	100	HA0	0.40	9.2	440
	180	JA0	0.24	4.4	530
80	62	HA0	0.40	9.2	440
	100	JA0	0.24	4.4	530

Category Max Temp.
135°C

導電性高分子ハイブリッドアルミ電解コンデンサ

Conductive Polymer Hybrid Aluminum Electrolytic Capacitors

HXE series

New

製品形状 Product Shape	チップ形 Surface Mount Type	
開発テーマ Development Theme	135度保証高リップル品の開発 Development of 135°C High Ripple Current Products	
開発の背景 Background of the Development	各種モータ・ドライブ回路の小形化に貢献する Contribution to the Downsizing of Various Motor Driver	
お客様のベネフィット Customer's Benefits	① 135°C 4,000時間 / 125°C 4,000時間 (高リップル電流規格) の選択保証 (F61, F80 : 2,000h) High Reliability Selective Endurance 135°C 4,000h or 125°C 4,000h (F61, F80 : 2,000h)	
	② 125°C 4,000時間保証時の定格リップル電流は従来品比1.8倍化 Endurance with Higher Ripple Current (ca. 1.8times vs.HXA series) : 4,000h at 125°C	
	③ 超低 ESR (低温特性大幅改善) Super Low ESR (Greatly Improving the Low-Temperature Characteristics)	
対象機能 Target ECU Function / Application	① 低電圧系モータ・ドライブ回路主回路平滑用 For Brushless DC Motor Driving Inverter DC-LINK Use	
	② 各種インバータ・ゲートドライブ回路 For Gate Driver of Driving Inverter Smoothing Use	
	③ 低電圧系 ECU 制御回路フィルタ用 For ECU Input Filtering Use	
開発スケジュール Development Schedule	サンプル:対応中 / Sample:Ongoing	量産 (F61~JA0) : 対応中 / Mass Production (F61 to JA0) : Ongoing 量産 (JH0) : 2020年上期 / Mass Production (JH0) : First half of 2020
AEC-Q200 Compliance	AEC-Q200に準拠します。詳細については別途お問い合わせ下さい。 AEC-Q200 compliant: Please contact Chemi-Con for more details, test data, information	

◆ Features

- High reliability and high voltage are realized by hybrid electrolyte
- Endurance with ripple current : 2,000 to 4,000hours at 135°C or 125°C
- Rated voltage range : 16 to 63Vdc
- Capacitance range : 22 to 560 μ F
- For automotive application and other high ambient temperature applications, etc.
- RoHS2 Compliant
- Halogen Free

◆ Newly added items : JH0 size ($\phi 10 \times 16.5L$) **Introductory**

WV (Vdc)	Cap (μ F)	ESR (m Ω max./20°C, 100kHz)	Rated ripple current (mArms/100kHz)	
			125°C	135°C
25	560	12	4,300	2,500
35	470	12	4,300	2,500
50	220	14	4,100	2,400
63	150	15	4,000	2,300

◆ Development Roadmap

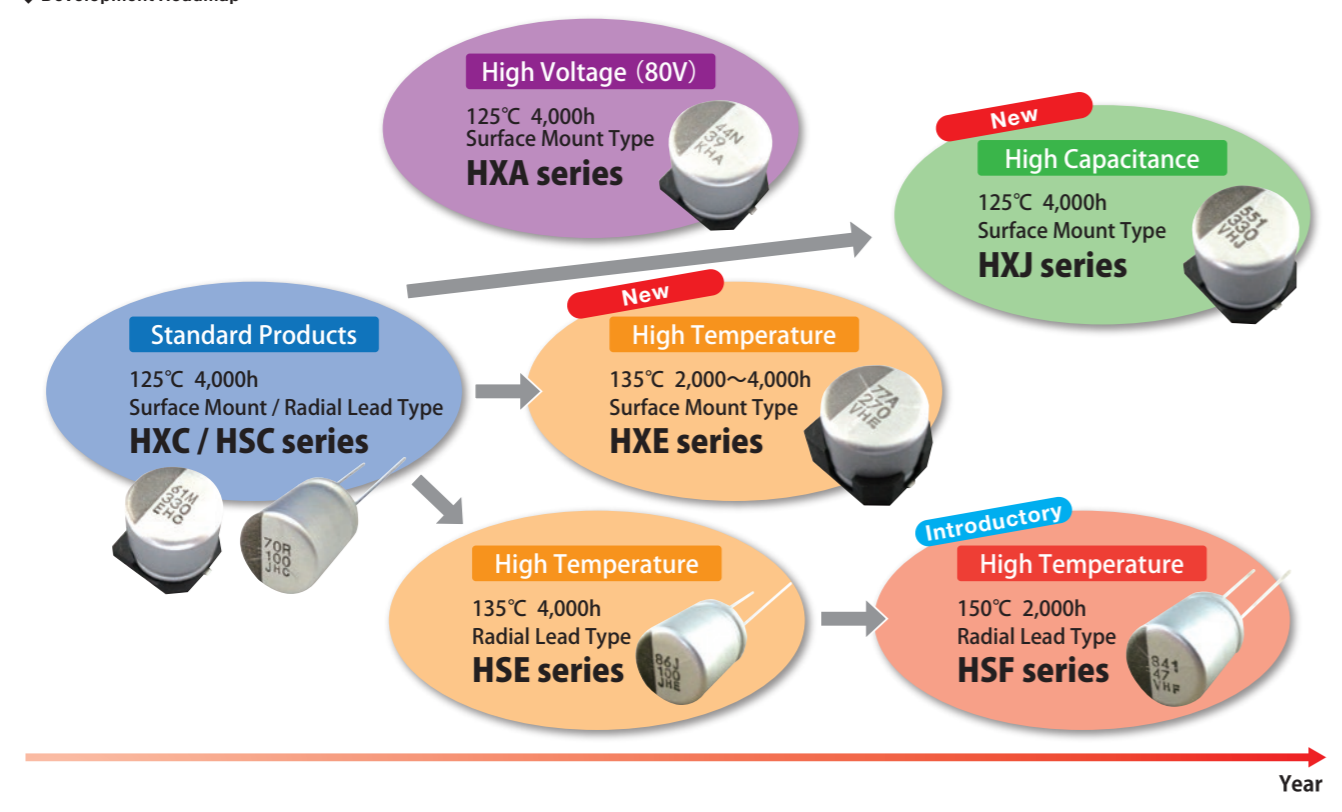

Category Max Temp.
125°C

導電性高分子ハイブリッドアルミ電解コンデンサ

Conductive Polymer Hybrid Aluminum Electrolytic Capacitors

HXJ series

New

製品形状 Product Shape	チップ形 Surface Mount Type	
開発テーマ Development Theme	125度保証高リップル品の開発 Development of 125°C High Ripple Current Products	
開発の背景 Background of the Development	各種モータ・ドライブ回路の小形化に貢献する Contribution to the Downsizing of Various Motor Driver	
お客様のベネフィット Customer's Benefits	① 125°C 4,000時間保証 Endurance : 125°C 4,000 hours	
	② HXCシリーズを高容量・高リップル電流化 Higher capacitance and ripple current than HXC series	
	③ 超低 ESR (低温特性大幅改善) Super Low ESR (Greatly Improving the Low-Temperature Characteristics)	
対象機能 Target ECU Function / Application	① 低電圧系モータ・ドライブ回路主回路平滑用 For Brushless DC Motor Driving Inverter DC-LINK Use	
	② 各種インバータ・ゲートドライブ回路 For Gate Driver of Driving Inverter Smoothing Use	
	③ 低電圧系 ECU 制御回路フィルタ用 For ECU Input Filtering Use	
開発スケジュール Development Schedule	サンプル:対応中 / Sample:Ongoing	量産:対応中 / Mass Production:Ongoing
AEC-Q200 Compliance	AEC-Q200に準拠します。詳細については別途お問い合わせ下さい。 AEC-Q200 compliant: Please contact Chemi-Con for more details, test data, information	

◆ Features

- High reliability and high voltage are realized by hybrid electrolyte
- Endurance with ripple current : 4,000 hours at 125°C
- Rated voltage range : 16 to 35Vdc
- Capacitance range : 56 to 820 μ F
- For automotive application and other high ambient temperature applications, etc.
- RoHS2 Compliant
- Halogen Free

◆ Standard ratings comparison : HXC and HXJ series

WV (Vdc)	Case size $\phi D \times L$ (mm)	Cap (μ F)		Rated ripple current (mArms/125°C, 100kHz)	
		HXC	HXJ	HXC	HXJ
25	6.3 x 5.8	56	82	900	1,080
	8 x 10	220	270	1,600	2,000
	10 x 10	330	560	2,000	2,800
35	6.3 x 5.8	47	56	900	1,080
	8 x 10	150	180	1,600	2,000
	10 x 10	270	330	2,000	2,800

◆ Standard ratings

WV (Vdc)	Cap (μ F)	Size Code	ESR (m Ω max./20°C, 100kHz)	Rated ripple current (mArms/125°C, 100kHz)	Part No.
16	150	F61	45	1,080	HHXJ160ARA151MF61G
	220	F80	27	1,680	HHXJ160ARA221MF80G
	470	HA0	20	2,000	HHXJ160□RA471MHA0G
	820	JA0	18	2,800	HHXJ160□RA821MJA0G
25	82	F61	50	1,080	HHXJ250ARA820MF61G
	150	F80	30	1,680	HHXJ250ARA151MF80G
	270	HA0	22	2,000	HHXJ250□RA271MHA0G
	470	JA0	20	2,800	HHXJ250□RA471MJA0G
35	560	JA0	20	2,800	HHXJ250□RA561MJA0G
	56	F61	60	1,080	HHXJ350ARA560MF61G
	100	F80	35	1,680	HHXJ350ARA101MF80G
	180	HA0	22	2,000	HHXJ350□RA181MHA0G
	330	JA0	20	2,800	HHXJ350□RA331MJA0G

Category Max Temp.
150°C

積層セラミックコンデンサ

Multilayer Ceramic Capacitors

KVF series / KVD series

製品形状 Product Shape	チップ形 Surface Mount Type / KVF series リード形 Dipped Radial Lead Type / KVD series	
開発テーマ Development Theme	150°C保証高信頼性品の開発 Development of 150°C High Reliability Products	
開発の背景 Background of the Development	各種ECU、モータ・ドライブの機電一体化、高信頼性化に貢献する Contribution to the Electromechanical Integration of Various ECU	
お客様のベネフィット Customer's Benefits	① 150°C保証、X8L特性(従来品は125°C保証、X7R特性) 150°C Max.X8L(Conventional 125°C X7R)	
	② 温度サイクル1,000サイクル対応 Temperature Cycles Resistance 1,000 Cycles	
	③ 定格リップル電流規定 Setting the Rated Ripple current	
対象機能 Target ECU Function / Application	① ブラシレスDCモータ・駆動インバータ・スナバ用 For Brushless DC Motor Drive Inverter Snubber Use	
	② DC-DCコンバータ平滑用 For DC-DC Converter Input/Output Ripple Filter	
	③ アクチュエータ直付けのノイズ低減用 For Various Actuator Contact Noise Suppressor	
開発スケジュール Development Schedule	サンプル:対応中 / Sample:Ongoing	量産:対応中 / Mass Production:Ongoing
AEC-Q200 Compliance	AEC-Q200に準拠します。詳細については別途お問い合わせ下さい。 AEC-Q200 compliant: Please contact Chemi-Con for more details, test data, information	

KVF Series

RoHS2 Compliant AEC-Q200

Temperature cycle : 1,000 cycles

◆ Features

- Temperature range : -55 to +150°C
- Temperature characteristics : X8L
- Excellent noise absorption.
- Automotive grade (AEC-Q200)

◆ Construction

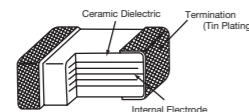

1. Category Temperature Range	-55~+150°C
2. Rated Voltage Range	25, 50, 100 Vdc
3. Rated Capacitance Range	0.033~15 μF
4. Rated Capacitance Tolerance	M (±20%)
5. Temperature Characteristics	X8L
6. Rated Ripple Current	Size Code 31 32 43 55 Arms 0.3 0.5 1.0 2.0

Rated Voltage (Vdc)	Cap (uF)	Nominal Size (mm)	Max. Ripple Current (Arms @ 10kHz~1MHz)	Part No.
25	10	5.7 × 5.0	2.0	KVF250L106M55NHT00
	15			KVF250L156M55NHT00
50	4.7	5.7 × 5.0	2.0	KVF500L475M55NHT00
	6.8			KVF500L685M55NHT00
100	1.0	5.7 × 5.0	2.0	KVF101L105M55NLT00
	1.5			KVF101L155M55NLT00

KVD Series

RoHS2 Compliant AEC-Q200

Temperature cycle : 1,000 cycles

◆ Features

- Temperature range : -55 to +150°C
- Temperature characteristics : X8L
- Small in size and wide capacitance range. Max. 15μF is available.
- Epoxy resin (UL94 V-0) used for coating.
- Automotive grade (AEC-Q200)

◆ Construction

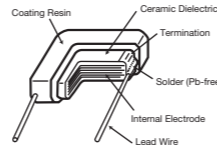

1. Category Temperature Range	-55~+150°C
2. Rated Voltage Range	25, 50, 100 Vdc
3. Rated Capacitance Range	0.1~15 μF
4. Rated Capacitance Tolerance	M (±20%)
5. Temperature Characteristics	X8L
6. Rated Ripple Current	Size Code 32 43 55 Arms 0.3 0.8 1.0

Rated Voltage (Vdc)	Cap (uF)	Nominal Size (mm)	Max. Ripple Current (Arms @ 10kHz~1MHz)	Part No.
25	10	7.5 × 9.0	1.0	KVD250L106M55A0T00
	15			KVD250L156M55A0T00
50	4.7	7.5 × 9.0	1.0	KVD500L475M55A0T00
	6.8			KVD500L685M55A0T00
100	1.0	7.5 × 9.0	1.0	KVD101L105M55A0T00
	1.5			KVD101L155M55A0T00

We support industrial market by supplying super large size and super high capacitance MLCCs

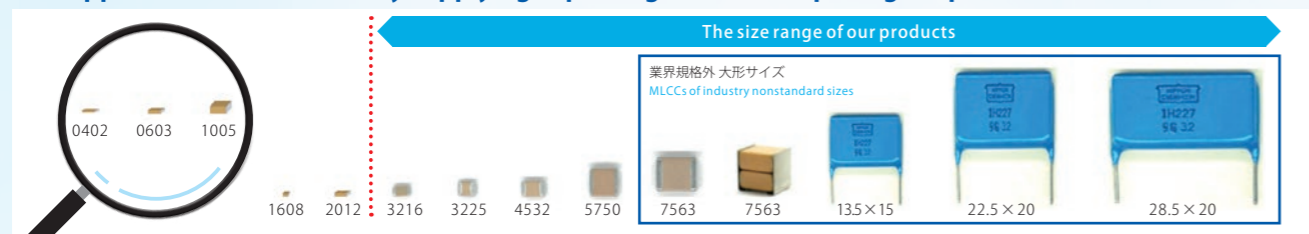

業界規格外 大形サイズ
MLCCs of industry nonstandard sizes

ナノ結晶合金コモンモードコイル

Nanocrystalline Coils

FL-V series

High Permeability
μ: OVER 30,000

New

製品形状 Product Shape	トロイダル形 Toroidal type	
開発テーマ Development Theme	高透磁率コモンモードコイルの開発 Development of High permeability Common mode Coils	
開発の背景 Background of the Development	コモンモードコイルの小型、軽量化により、省スペース化に貢献する contribution to space-saving design by small size and weight saving of a common mode coil.	
お客様のベネフィット Customer's Benefits	① 小型、軽量化 Miniaturization Weight Reduction	
	② 巻線分布容量の低下による共振周波数の高周波数化 High frequency of resonance frequency due to decrease in winding distribution capacity	
	③ 500kHz~3MHz帯域における広域周波数でのノイズ軽減効果 Noise reduction effect at a wide frequency from 500kHz to 3MHz	
対象機能 Target ECU Function / Application	① 車載充電器用コモンモードノイズフィルタ for On-Board Charger	
	② 車載DC/DCコンバータ for DC/DC converter	
	③ モーターノイズ低減用 For motor noise reduction	
開発スケジュール Development Schedule	サンプル:対応中 / Sample:On going	量産:対応中 / Mass Production:On going

◆ Standard Rating

Coil Part No. *	Core Part No.	Rated voltage [V]	Rated Current [A]	Inductance		D.C.R. mΩ (max)	Winding mmφ×lines	Outside Dimensions		
				10kHz [mH]	100kHz [mH]			D1 [mm]	D2 [mm]	W [mm]
LDFL004272V5-□0E	F110705	250	3.5	6.0	2.7	38	0.55 × 1P	15.0	16.0	12.0
LDFL006102V5-□0E			5.5	2.3	1.0	16	0.7 × 1P			
LDFL006832VD-□0E	F221407	250	5.5	18.3	8.3	26	0.9 × 1P	27.0	31.0	17.5
LDFL009412VD-□0E			9	9.1	4.1	16	1.1 × 1P			
LDFL012282VD-□0E			12	6.2	2.8	9.5	1.3 × 1P			
LDFL014172VD-□0E			14	3.8	1.7	7	1.4 × 1P			
LDFL007652V6-□0E	F221310	250	7	16.3	6.5	22	1.0 × 1P	29.0	31.0	21.0
LDFL010302V6-□0E			10	6.7	3.0	11	1.2 × 1P			
LDFL012202V6-□0E			12	4.5	2.0	7.5	1.3 × 1P			
LDFL008123VV-□0E	F251513	250	8	25.3	11.5	26	1.1 × 1P	30.5	34.0	23.5
LDFL011742VV-□0E			11	16.2	7.4	15	1.3 × 1P			
LDFL013412VV-□0E			13	9.1	4.1	12	1.4 × 1P			
LDFL015372VBU□0E	F281815	700	15	8.1	3.7	6.7	1.7 × 1P	36.0	40.0	29.5
LDFL021252VBU□0E			21	5.4	2.5	4.5	1.9 × 1P			
LDFL026152VBU□0E			26	3.3	1.5	2.9	1.5 × 2P			
LDFL020592VJU□0E	F372315	700	20	12.9	5.9	5.7	1.5 × 2P	48.0	50.0	32.5
LDFL027282VJU□0E			27	6.2	2.8	3.1	1.7 × 2P			
LDFL039172VJU□0E			39	3.7	1.7	1.5	2.0 × 2P			

* For Coil Part No., vertical type = V, horizontal type = H are used

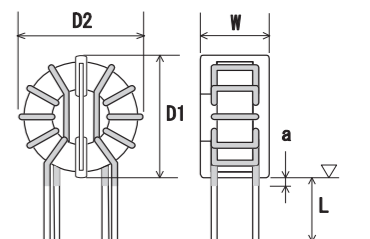

Category Max Temp.
105°C

アルミ電解コンデンサ

Aluminum Electrolytic Capacitors

KYC series

製品形状 Product Shape	リード形(CE04) Radial Lead Type	
開発テーマ Development Theme	105°C保証低ESR・高リプル電流品の開発 Development of 105°C Low ESR, High Ripple Current Products	
開発の背景 Background of the Development	二輪車向けACGスターター用途に最適 For motorcycle ACG starter	
お客様のベネフィット Customer's Benefits	① 105°C 3,000~5,000時間保証 Endurance with ripple current : 3,000 to 5,000 hours at 105°C	
	② 定格リプル電流は従来品 (KYシリーズ) 比、最大1.3倍化 At most 1.3times higher Rated Ripple Current than that of KY series	
	③ 静電容量は従来品 (KYシリーズ) 比、最大200%アップ At most 200% higher Capacitance than that of KY series	
対象機能 Target ECU Function / Application	① 電動パワーステアリングに代表される小型モータ系制御主回路 For Electric Power Steering ECU, Various Small Motor Driver	
	② 二輪車向けACGスターター用途 For motorcycle ACG starter	
	③ 低電圧系モータ・ドライバ主回路平滑用 For Low Voltage Motor Driver Power Circuit DC-LINK Use	
開発スケジュール Development Schedule	サンプル:対応中 / Sample:Ongoing	量産:対応中 / Mass Production:Ongoing
AEC-Q200 Compliant	AEC-Q200に準拠します。詳細については別途お問い合わせください AEC-Q200 compliant: Please contact Chemi-Con for more details, test data, information	

KYC series

- ◆ Features
- Downsizing and high ripple current version of KY series
- Endurance with ripple current : 3,000 to 5,000 hours at 105°C
- Rated voltage range: 16 to 50V, Capacitance range: 180 to 12,000μF
- RoHS2 Compliant

◆ Excerpt from the Standard Ratings

WV (Vdc)	Cap (μF)	Case size φD×L(mm)	ESR (Ω max./20°C, 100kHz)	Rated ripple current (mArms/105°C, 100kHz)	Part No.
16	4,700	12.5×25	0.037	2,820	EKYC160E□□472MK25S
25	3,900	12.5×30	0.029	3,120	EKYC250E□□392MK30S
35	1,800	12.5×25	0.037	2,820	EKYC350E□□182MK25S
	3,300	16×25	0.031	3,240	EKYC350E□□332ML25S
50	2,700	18×30	0.024	3,710	EKYC500E□□272MM30S

◆ Electronic characteristic comparison KY and KYC

	Cap (μF)		Ripple current (mArms) (105°C, 100kHz)	
	KY	KYC	KY	KYC
16V(φ10×16L)	680	1,300	1,210	1,570
25V(φ12.5×20L)	1,000	2,000	1,900	2,150
25V(φ16×20L)	1,800	3,600	2,530	2,530
25V(φ16×30L)	3,300	6,200	3,450	3,580
35V(φ10×12.5L)	220	390	865	1,120
50V(φ16×25L)	1,000	1,600	2,555	3,240

Max 200%

Max 130%

◆ Overall Positioning of High heat Resistance and High Ripple Current Products (Radial Lead Type)

Example of Performance Improvement (Low Voltage Range)

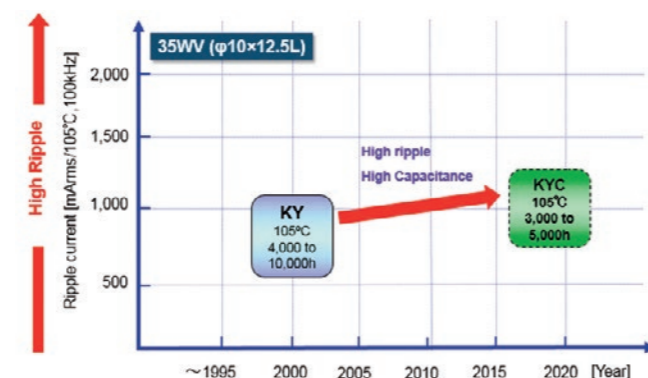
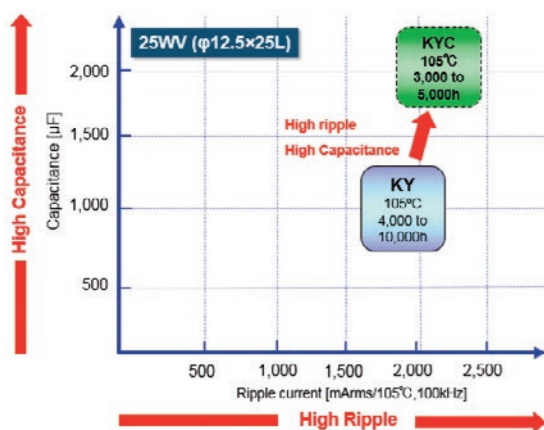

Acceleration
15G

Introductory

アルミ電解コンデンサ

Aluminum Electrolytic Capacitors

Vibration Resistance Structure (Snap-In Type)

製品形状 Product Shape	基板自立形(CE692) Snap-In Type	
開発テーマ Development Theme	高耐振動構造の開発 Development of High Vibration Resistance Structure	
開発の背景 Background of the Development	車載充電器の信頼性向上の貢献する Contribution to the Improvement of Reliability for On-Board Battery Charger	
お客様のベネフィット Customer's Benefits	① 加速度15Gで高周波(最大2kHz)での耐振動性を実現(製品本体固定時) Realize the Vibration Resistance at High Frequencies(up to 2kHz)in Acceleration 15G ※ The capacitor body shall be clamped	
	② 幅広い定格電圧(400~450V) / 静電容量範囲に対応 Adapted to a Wide Range of Rated Voltage (400~450V) and Capacitance	
	③ 各種端子形状に対応 Adapted to various terminal shape	
対象機能 Target ECU Function / Application	① 車載充電器平滑回路 For the Power Circuit Smoothing of On-Board Charger	
	② 超小型モビリティ駆動インバータ主回路平滑用 For Ultra Compact Mobility Driving Inverter DC-LINK Use	
	③ 各種二輪車電装品 For Various Motorcycle Electrical Equipment	
開発スケジュール Development Schedule	サンプル:お問い合わせください / Sample: Please contact us	量産:お問い合わせください / Mass Production: Please contact us

◆ Vibration resistance issues and improve point of a standard structure

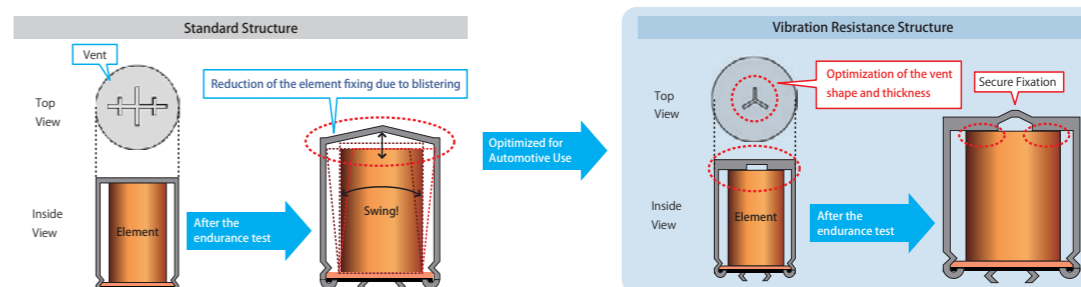

◆ Evaluation Test Results

Acceleration	Standard Structure	Vibration Resistance Structure
10G	No abnormality	No abnormality
15G	Fracture of the Tab Electrode Section	No abnormality

Evaluation Test has Conducted Based on KMW series / Evaluation Conditions : Sin Wave Ratio 10~2000Hz, Each Axis 2hours, 1 cycle about 10 minutes, RT



◆ Various Type of Vibration Resistance Aluminum Electrolytic Capacitors

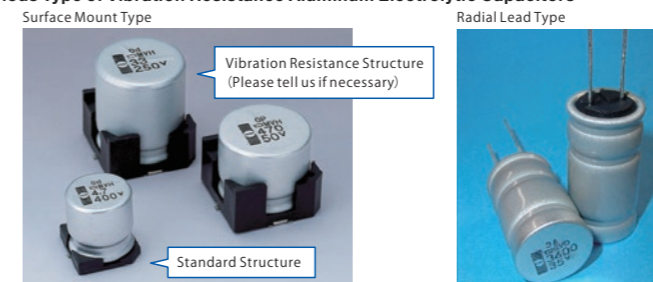

GVA Series

- Structure of higher vibration by GPA series (acceleration 392m/s², 40G)
- High temperature resistance 100 hours at 150°C
- Designed for electric power steering and ECU (include engine control, direct fuel injection) etc.
- Rated voltage range : 25 to 100V, Capacitance range : 430 to 5,100μF
- Solvent resistant type
- RoHS Compliant

GVD Series

- Structure of higher vibration resistance by GPD series (acceleration 392m/s², 40G)
- High temperature resistance 100 hours at 150°C
- Designed for electric power steering and ECU (include engine control, direct fuel injection) etc.
- Rated voltage range : 25 to 100V, Capacitance range : 510 to 8,200μF
- Solvent resistant type
- RoHS Compliant

Category Max Temp.

125°C

Upgrade

セラミックバリスタ TNR™

Metal Oxide Varistors TNR™

SV series

製品形状 Product Shape	ディスク形 Disk Type	
開発テーマ Development Theme	125°C保証難燃性品の開発 Development of 125°C Flame Retardance Products	
開発の背景 Background of the Development	車載充電器の発火・発煙リスクの低減に貢献する Contribution to the Reduction in Fire Hazard Risk for On-Board Battery Charger	
お客様のベネフィット Customer's Benefits	①使用温度範囲 -40~+125°C Operating Temperature Range: -40~+125°C	
	②高難燃性外装材料(低分子シロキサン低減シリコーン樹脂)を採用し定格を超える過電圧印加による破壊時に外装の燃焼及び飛散を抑制 Little Scatter at the Destruction under Overvoltage	
	③温度サイクル性(-40°C⇄+125°C)1,000サイクル対応 Temperature cycle: -40°C 30 minutes ⇄ +125°C 30 minutes 1,000 cycles	
対象機能 Target ECU Function / Application	①車載充電器過電圧保護回路用 For On-Board Charger Surge Protection Use	
	②急速充電器過電圧保護回路用 For Quick Charger Surge Protection Use	
	③ロードダンブサージ吸収用 Absorption of Automotive Load Dump Surge	
開発スケジュール Development Schedule	サンプル:対応中 / Sample:Ongoing	量産:対応中 / Mass Production:Ongoing
取得安全規格 Recognized Safety Standards Should be more than 220V	UL1449. : File E323623, CSA C22.2 No.1 Class 2221 01 : File LR-97864 [CSA C22.2 No.269 移行中], VDE : File 118623, IEC60950-1 AnnexQ(10SV : 471k~) [IEC 62368-1 G8.2 対応済], CQC : GB/T10193-GB/T10194-GB4943.1-GB8898 (ファイルNo.はお問い合わせ下さい。)	

TNR SV series

Low varistor voltage



- ◆ Features
- High temperature operating : 1,000h at 125°C.
 - Material of Coating resin : UL94V-0 and Halogen free.

Typical Proposal Ratings

Size (mm)	Varistor Voltage V1mA (V)	Max. Peak Current 8 / 20 μs (A)
φ5~φ20	22(20~24)~68(61~75)	125A / 2 times~2,000A / 2 times

TNR SV series



◆ Features



- Environmental characteristics(Upgrade)
- High temperature operating : 1,000h at 125°C
- Damp heat operating : 1,000h at 85°C, 85%RH
- Temperature cycle : -40°C ⇄ 125°C, 1,000cycles
- Material of coating resin : UL94V-0 and Halogen free
- AEC-Q200 compliant (size: φ10~φ14 V1mA(V) : 220~680)

Typical Proposal Ratings

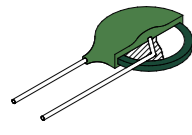

Size (mm)	Varistor Voltage V1mA (V)	Max. Peak Current 8 / 20 μs (A)
φ7	220(198~242) ~ 510(459~561)	1,750A / 1time
φ10~φ20	220(198~242) ~ 1,000(900~1,100)	3,500A / 1time ~ 10,000A / 1time

◆ History of Product Development "Safety First" is our Policy

V series Epoxy resin



Standard behavior

↓

Only Sparked !

SV series Silicon resin

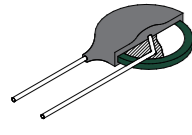
High Dynamic Range

over 94dB

Introductory

CMOSカメラモジュール

CMOS Camera Module

High Dynamic Range Camera

製品形状 Product Shape	各種対応可 FPC Connection / Waterproof housing	
開発テーマ Development Theme	ハイダイナミックレンジ品の開発 Development of High Dynamic Range Cameras	
開発の背景 Background of the Development	モニタリング性能の向上に寄与する Contribution to the improvement of monitoring performance	
お客様のベネフィット Customer's Benefits	①ハイダイナミックレンジ(アナログ/デジタル) High Dynamic Range (Analog / Digital)	 Automotive Adoption Example (For Drive Recorder Use)
	②防水構造 Waterproof structure adaptable (IPX7)	
	③長距離伝送可能(NTSC/HD-TVI/AHD/LVDS) Long Distance Transmission adaptable (NTSC/HD-TVI/AHD/LVDS)	
対象機能 Target ECU Function / Application	①ドライブ・レコーダ用 For Drive Recorder Use	
	②サイドビュー・モニター用 For Side Blind Monitor Use	
	③バックビュー・モニター用 For Back Blind Monitor Use	
開発スケジュール Development Schedule	サンプル:2020年下期 Sample:Second half of 2020	量産:2021年上期 Mass-Production:First half of 2021

◆ Features(HD type)

Sensor Spec.	1,280(H)x800(V)
HFOV	140°
Dynamic Range	94dB
Output / I / F	Analog Out/75 Ω coax
Data Format	NTSC
External Dimensions	25mm (W)x23mm (L)x22mm (H)
IP Code	IPX7
Operating Temperature	-30°C~+80°C

◆ Appearance



◆ Features(Full HD type)

Sensor Spec.	1,920(H)x1,080(V)
HFOV	130° (T.B.D.)
Dynamic Range	120dB
Output / I / F	50 Ω coax
Data Format	LVDS
External Dimensions	25mm (W)x23mm (L)x22mm (H) (T.B.D.)
IP Code	IPX7 (T.B.D.)
Operating Temperature	-30°C~+80°C

◆ Appearance



◆ Automotive Adoption Example

Drive Recorder



Side Blind Spot Monitor / Rear Blind Spot Monitor



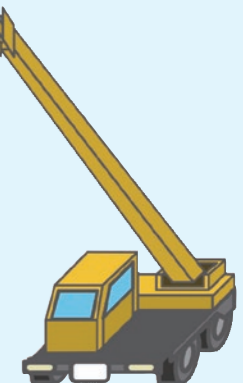

走る For Powertrain Controls

アルミ(導電性高分子アルミ固体)電解コンデンサ
Aluminum Electrolytic Capacitors
(Conductive Polymer Electrolyte Type)

エンジンECUに代表されるパワートレインやシャシー系制御等に最適
Best for Engine ECU, Direct Injection Driver, Various Powertrain & Chassis ECU

マイコン電源回路例と推奨部品 Example of Microcomputer Power Circuit and Recommended Products

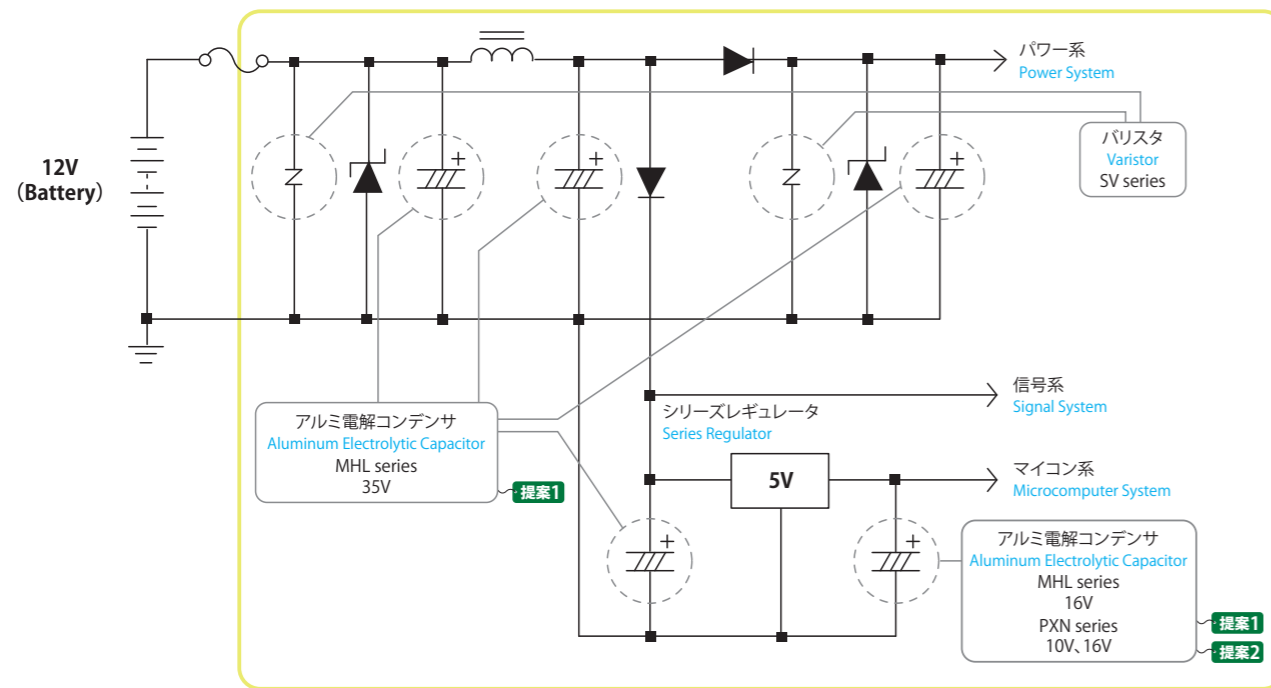

インジェクタ駆動回路例と推奨部品 Example of Injector Driver Circuit and Recommended Products

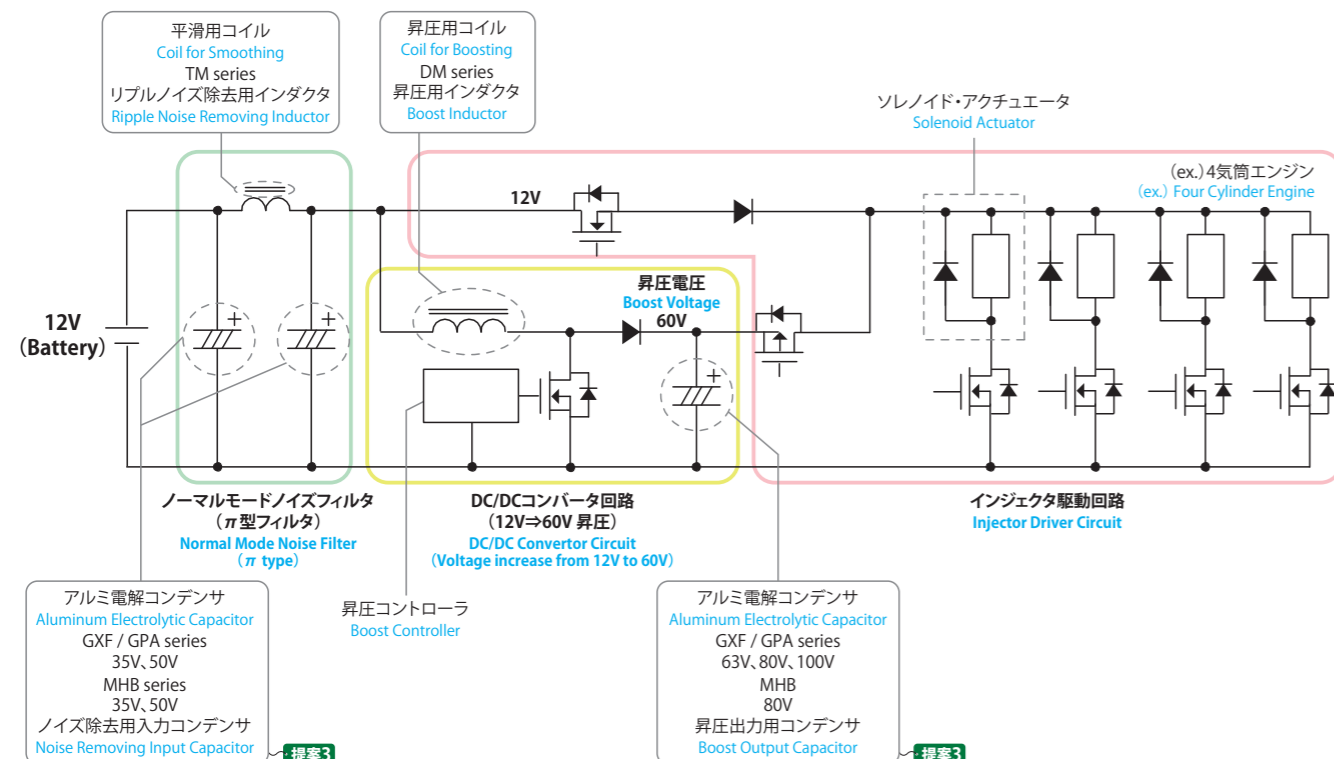

提案1 アルミ電解コンデンサ ALUMINUM ELECTROLYTIC CAPACITORS

Alchip™ MHL series

AEC-Q200

Specifications

- SMD Capacitor $\phi 6.3 \times 5.8 \text{L} \sim \phi 10 \times 10 \text{L}$
- Voltage: 10~35V, Cap: 47~680 μF
- High temperature 125°C 2,000~4,000h
- Miniaturized and long life.
- Vibration resistance structure (as needed)

High Temp & Long Life
SMD Capacitor for ECU
MVH ▶ MHL series

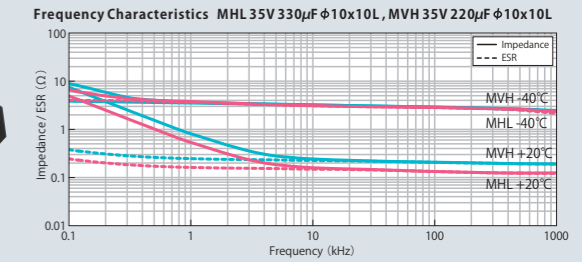

Dimensions (mm)

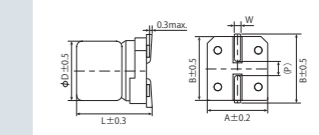

Size Code	ϕD	L	A	B	C	W	P
F61	6.3	5.8	6.6	6.6	7.2	0.5 to 0.8	1.9
F80	6.3	7.7	6.6	6.6	7.2	0.5 to 0.8	1.9
HA0	8.0	10.0	8.3	8.3	9.0	0.7 to 1.1	3.1
JA0	10.0	10.0	10.3	10.3	10.0	0.7 to 1.1	4.5

提案2 導電性高分子アルミ固体電解コンデンサ CONDUCTIVE POLYMER ALUMINUM SOLID CAPACITORS

NPCAP™ PXN series

AEC-Q200

Specifications

- SMD Conductive Polymer Capacitor $\phi 5 \times 5.8 \text{L} \sim \phi 10 \times 7.7 \text{L}$
- Voltage: 2.5~16V, Cap: 56~1,200 μF
- High reliability up to 5,000h at 105°C
- Super low ESR products
- 85°C 85% RH 1,000h

Super Low ESR
SMD Polymer Capacitor
PXD ▶ PXN series

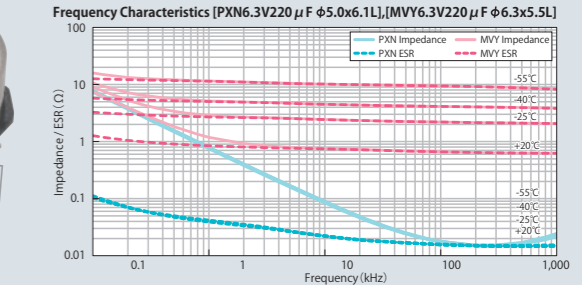

Dimensions (mm)

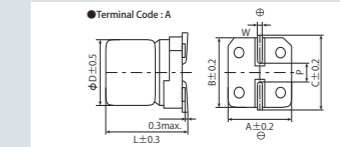

Size Code	ϕD	L	A	B	C	W	P
E61	5	5.8	5.3	5.3	5.9	0.5 to 0.8	1.4
F61	6.3	5.8	6.6	6.6	7.2	0.5 to 0.8	1.9
H70	8	6.7	8.3	8.3	9.0	0.6 to 1.1	3.1
J80	10	7.7	10.3	10.3	11.0	0.6 to 1.1	4.5

Temperature Characteristic

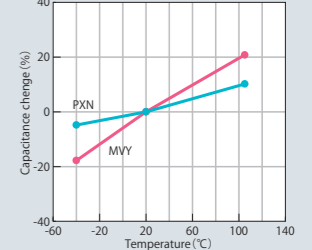

提案3 アルミ電解コンデンサ ALUMINUM ELECTROLYTIC CAPACITORS

Alchip™ MHB series

AEC-Q200

Specifications

- SMD Capacitor $\phi 12.5 \times 13.5 \text{L} \sim \phi 18 \times 21.5 \text{L}$
- Voltage: 25~100V, Cap: 110~3,900 μF
- High reliability 125°C 1,500~3,000h
- Large sizes newly added.
- Vibration resistance structure (as needed)

High Temp & Long Life
SMD Capacitor for ECU
MVH ▶ MHB series

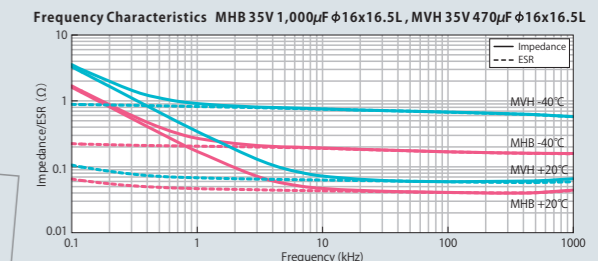

Dimensions (mm)

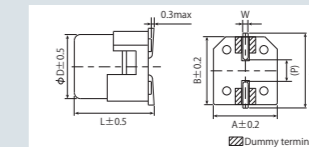

Size Code	ϕD	L	A	B	C	W	P
KE0	12.5	13.5	13.0	13.0	13.7	1.0 to 1.3	4.2
KG5	12.5	16.0	13.0	13.0	13.7	1.0 to 1.3	4.2
KN0	12.5	21.5	13.0	13.0	13.7	1.0 to 1.3	4.2
LH0	16.0	16.5	17.0	17.0	18.0	1.0 to 1.3	6.5
LN0	16.0	21.5	17.0	17.0	18.0	1.0 to 1.3	6.5
MH0	18.0	16.5	19.0	19.0	20.0	1.0 to 1.3	6.5
MN0	18.0	21.5	19.0	19.0	20.0	1.0 to 1.3	6.5

Rated Voltage (Vdc)	Cap (μF)	Size Code	ESR (Ω max./100k~400kHz)		Rated Ripple Current (mA rms/125°C, 100k~400kHz)	Part No.
			20°C	-40°C		
35	560	KE0	0.060	0.30	1,320	EMHB350ARA561MKE05
	1,000	LH0	0.047	0.24	1,820	EMHB350GDA102MLH05
	1,300	MH0	0.045	0.23	2,000	EMHB350GDA132MMH05
	130	KE0	0.220	1.54	540	EMHB800ARA131MKE05
80	240	LH0	0.150	1.05	780	EMHB800GDA241MLH05
	510	MN0	0.070	0.49	1,910	EMHB800GDA511MMN05

For Small Motor Controls

コンデンサ(アルミ電解、積層セラミック)、チョークコイル
Capacitors (Aluminum Electrolytic, Multilayer Ceramic), Choke Coils

電動パワーステアリングに代表される小型モータ系制御等に最適
Best for Electric Power Steering ECU, Various Small Motor Driver

主回路例と推奨部品 Example of Main Circuit and Recommended Products

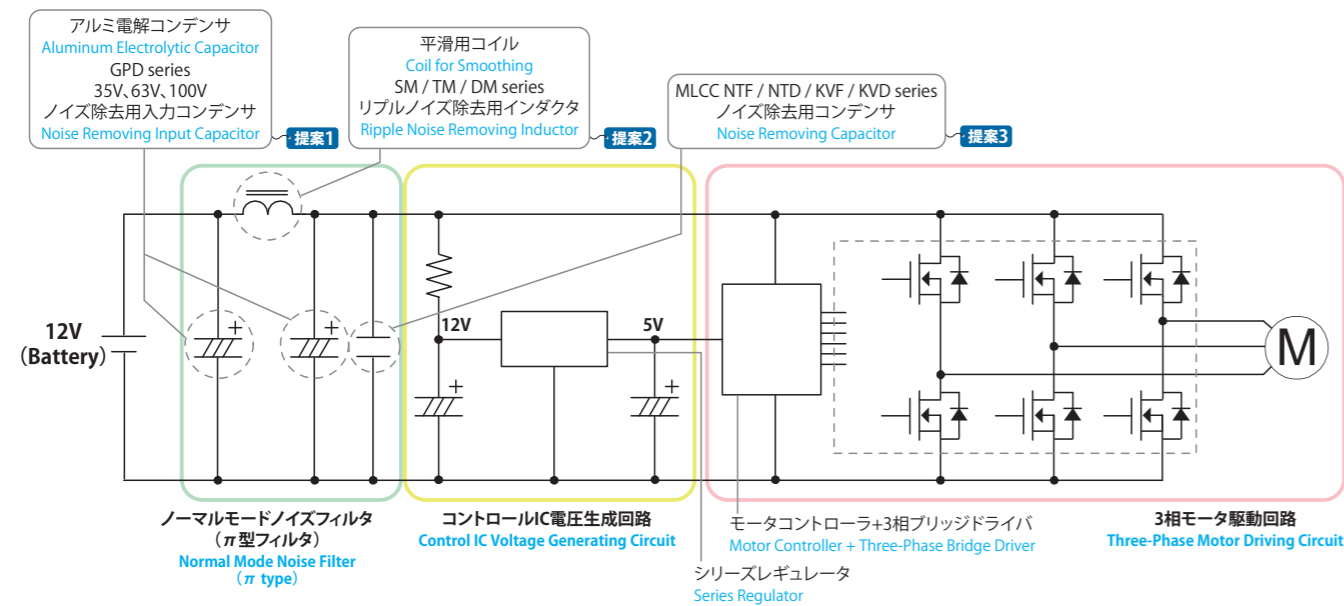

150°C保証高信頼性品のご紹介 Introduction of 150°C high reliability products

電動パワーステアリングや電動ウォーターポンプ、トランスミッションに最適
For Electric power steering and Electric water pump and Transmission control unit

MXB series AEC-Q200

Specifications

- Endurance : 1,000 hours at 150°C
- Rated voltage range : 25 & 35V, Nominal capacitance range : 330 to 2,400μF
- Solvent resistant type.
- Vibration resistant structure.
- RoHS2 Compliant

Excerpt from the Standard Ratings

Rated voltage (Vdc)	Cap (μF)	Size code	ESR (Ω max./100kHz)		Rated ripple current (mA rms/150°C, 100kHz)	Part No.
			20°C	-40°C		
25	560	KE0	0.14	2.1	860	EMXB250□RA561MKE0S
	1,000	LH0	0.1	1.5	1,120	EMXB250□RA102MLH0S
	2,400	MN0	0.058	0.87	1,560	EMXB250□RA242MMN0S
330	KE0	0.27	8.1	670	EMXB350□RA331MKE0S	
	560	LH0	0.16	4.8	920	EMXB350□RA561MLH0S
1,200	MN0	0.084	1.7	1,320	EMXB350□RA122MMN0S	

Capacitance comparison MVH and MXB series

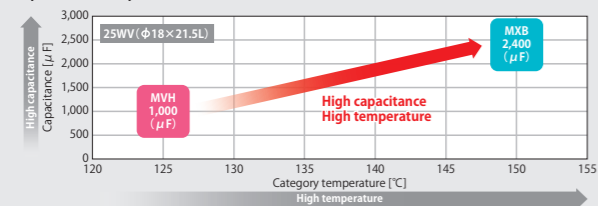

GQB series AEC-Q200

Specifications

- Endurance with ripple current : 1,000 hours at 150°C
- Rated voltage range : 25 & 35V, Nominal capacitance range : 100 to 800μF
- Solvent resistant type.
- RoHS2 Compliant

Excerpt from the Standard Ratings

Rated voltage (Vdc)	Cap (μF)	Case size φD×L (mm)	ESR (Ω max./100kHz)		Rated ripple current (mA rms/150°C, 100kHz)	Part No.
			20°C	-40°C		
25	1,800	16×20	0.07	1.0	1,460	EGQB250E□□182ML20H
	2,400	18×20	0.058	0.9	1,560	EGQB250E□□242MM20H
	2,700	16×25	0.05	0.8	1,720	EGQB250E□□272ML25H
	3,600	18×25	0.042	0.7	1,800	EGQB250E□□362MM25H
35	910	16×20	0.1	3.0	1,260	EGQB350E□□911ML20H
	1,200	18×20	0.084	2.0	1,320	EGQB350E□□122MM20H
	1,400	16×25	0.067	2.0	1,600	EGQB350E□□142ML25H
	1,800	18×25	0.058	1.4	1,680	EGQB350E□□182MM25H

Rated ripple current comparison GPD and GQB series

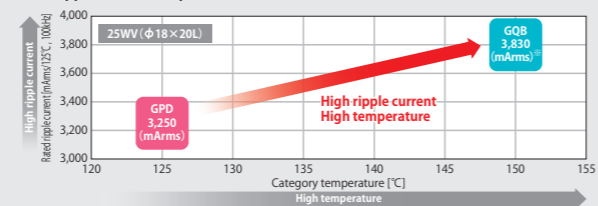

※ 125°Cに換算したリップル電流値

提案1 アルミ電解コンデンサ ALUMINUM ELECTROLYTIC CAPACITORS

GPD series AEC-Q200

Specifications

- Radial Lead Capacitor φ12.5x20L~φ18x40L
- Voltage: 25~100V, Cap: 160~12,000 μF
- Higher ripple current capability.
- High reliability 135°C 2,000 to 3,000h
- Guaranteed short time at 150°C

Higher Ripple Current & High Temperature
GPA ▶ GPD series

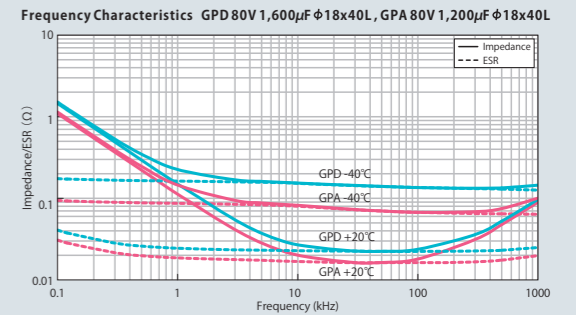

Recommended Standard Ratings

Rated Voltage (Vdc)	Cap (μF)	Case Size φD×L (mm)	ESR (Ω max./100kHz)		Rated Ripple Current (mA rms/125°C, 100kHz)	Part No.
			20°C	-40°C		
35	2,000	16x20	0.035	0.27	3,040	EGPD350ELL202ML20H
	7,500	18x40	0.018	0.10	7,070	EGPD350ELL752MM40H
	680	16x20	0.053	0.34	2,140	EGPD630ELL681ML20H
63	2,400	18x40	0.021	0.11	5,660	EGPD630ELL242MM40H
	270	16x20	0.067	0.47	2,050	EGPD101ELL271ML20H
100	910	18x40	0.026	0.14	5,280	EGPD101ELL911MM40H

Dimensions (mm)

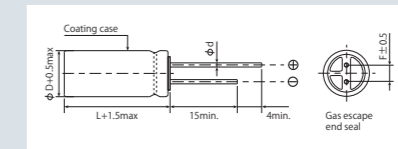

φD	12.5	14.5	16.0	18.0
φd	0.6	0.8	0.8	0.8
L	5.0	7.5	7.5	7.5

提案2 アモルファスチョークコイル AMORPHOUS CHOKE COILS

SM series

Features

- 低DCR(低損失)で高出力可能
- 被覆巻き線不要/レイヤーショートリスク無し
- 使用温度範囲:-40°C~+150°C
- Low DCR (Low Loss) and High Output
- No copper wire / Significantly reduce the layer short risk
- Temperature range:-40°C~+150°C



Dimensions

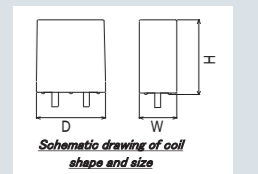

1. Specification

Part No.	Size	Outer diameter (typ.) [mm]			Electrical characteristics (typ.)			
		D	W	H	Rated Current [A]	Inductance [μH]	Rating	DCR [mΩ]
① LESM050010P18V1E	Size1	23.5	12.8	25.6	50A	2.4	1.3	0.33
② LESM030020P7DV1EF				20.6	30A	2.2	1.9	0.29
③ LESM0301R5P3FV1E				15.6	30A	2.1	1.5	0.26
④ LESM0400R9P5DV1E	Size2	19.4	10.7	20.6	40A	1.5	0.9	0.27
⑤ LESM0301R5P2DV1E				30A	2.2	1.3		

2. DC superposition characteristics

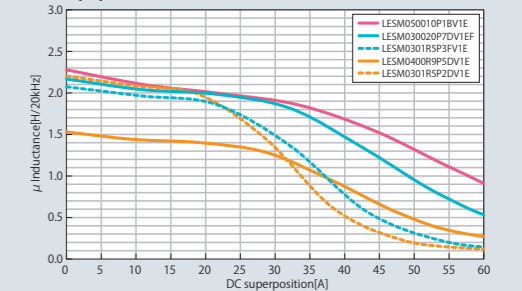

提案3 積層セラミックコンデンサ MULTILAYER CERAMIC CAPACITORS

NTD series

Features

- 温度特性はX7R特性
- 小形大容量で許容リップル電流が大きい
- 優れたノイズ吸収性能
- Temperature characteristic is X7R in EIA code
- Large capacitance by small size
- High permissible ripple current capability
- Excellent noise absorption

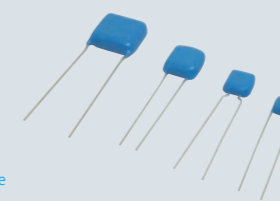

Recommended Standard Rating

Rated Voltage (Vdc)	Cap (μF)	Part No.
25	33	KTD250B336M55A0T00
35	22	KTD350B226M55A0T00
50	15	KTD500B156M55A0T00
100	6.8	KTD101B68M55A0T00

NTJ series Upgrade

表面実装金属キャップ形
Surface mount device (Metal cap type)

Recommended Standard Rating

Rated Voltage (Vdc)	Cap (μF)	Part No.
25	68	KTJ250B686M55BFT00
35	47	KTJ350B476M55BFT00
50	33	KTJ500B336M55BFT00
100	10	KTJ101B106M55BFT00

NTF series

温度サイクル1,000サイクル保証
Heat Cycle 1,000 cycles

Recommended Standard Rating

Rated Voltage (Vdc)	Cap (μF)	Part No.
25	33	KTF250B336M55NHT00
35	22	KTF350B226M55NHT00
50	15	KTF500B156M55NHT00
100	6.8	KTF101B68M55FHT00

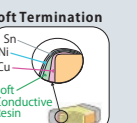

For Safety & Body Controls

アルミ電解コンデンサ、
CMOSカメラモジュール
Aluminum Electrolytic Capacitors,
CMOS Camera Modules

エアバッグECUやボディ系電装品等に最適
Best for Airbag ECU, Various Body Electronics ECU

エアバッグ回路例と推奨部品 Example of Airbag Circuit and Recommended Products

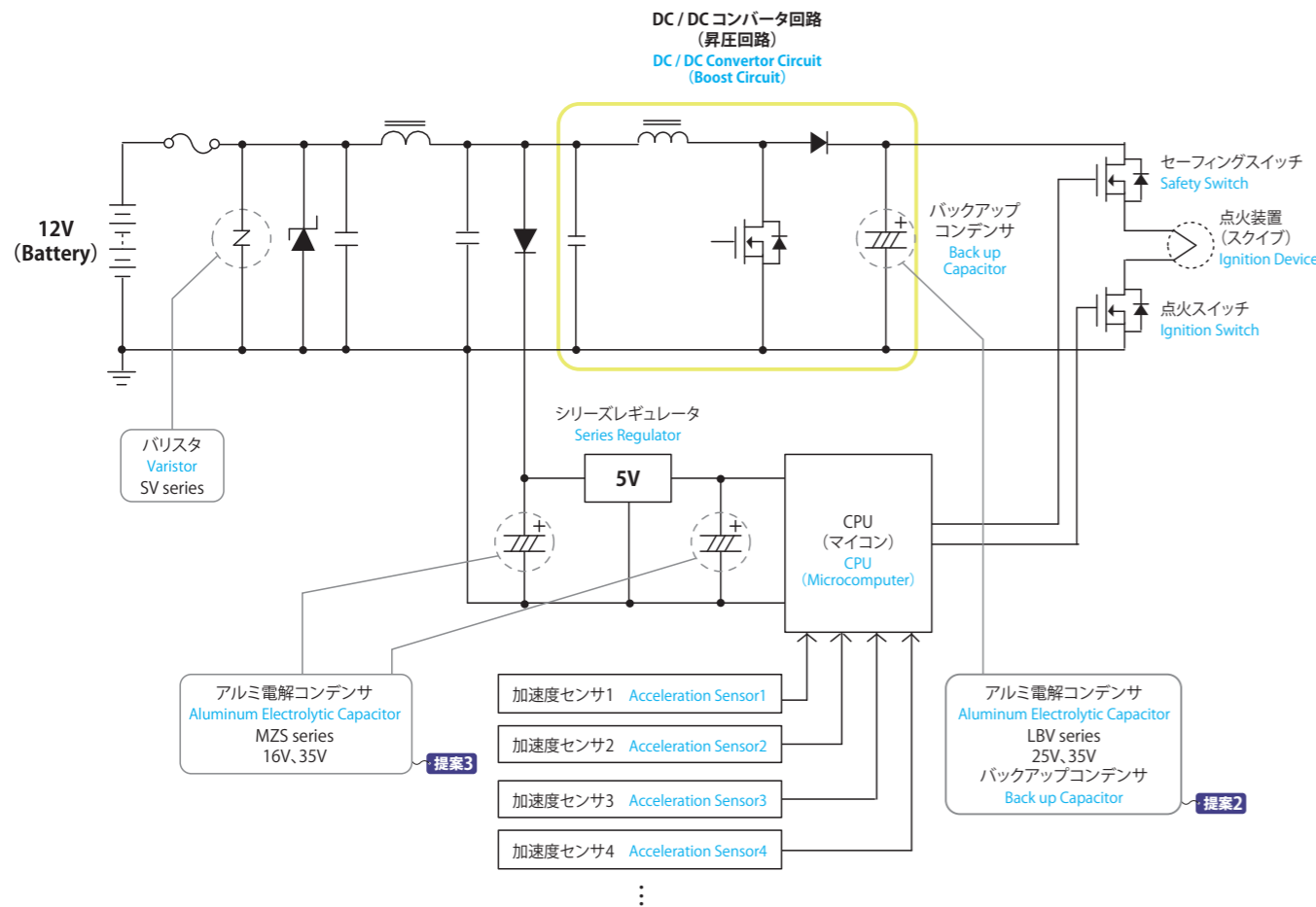

提案1 CMOSカメラモジュール CMOS CAMERA MODULES

NCM series

Features

- ハイダイナミックレンジ対応、グローバルシャッターなど車載、産業機器向け製品をラインナップ
- 高画素・長距離通信や画像切り出し・歪補正などの画像処理にも対応可能
- 防水筐体や周辺回路を含めたカスタム設計対応
- Lineup of products for automotive and industrial equipment such as high dynamic range compatible, global shutter
- It is also useful for image processing such as high pixel·long distance communications, image extraction / distortion correction
- Custom design support including waterproof casing and peripheral circuits

Application Examples

ドライブレコーダや、車室外モニター、その他監視系用途などに御提案いたします。
Event data recorder, vehicle exterior monitor, and monitoring-related application

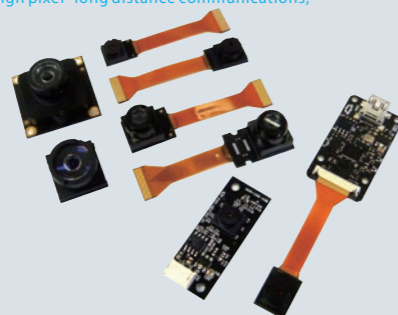

車室外モニター Vehicle outside view

- 光学サイズ Optical format : 1/4 inch
- 信号画素数 Image size : 640 (H) x 480 (V)
- F値 F number : 2.8
- 画角 (TYP) Angle of view (TYP) : 水平 132°, 垂直 104° Horizontal 132°, Vertical 104°
- 動作温度範囲 Operating temperature range : -30°C ~ +80°C
- 保存温度範囲 Storage temperature range : -40°C ~ +85°C
- 映像出力 Output format : NTSC



NCM03-ZB

提案2 アルミ電解コンデンサ ALUMINUM ELECTROLYTIC CAPACITORS

LBV series AEC-Q200

Specifications

- Radial Lead Capacitor $\phi 16 \times 20L \sim \phi 18 \times 40L$
- Voltage: 25 and 35V, Cap: 3,000 ~ 15,000 μF
- Super high capacitance and low ESR products
- Suitable for Airbag power reserve capacitor
- High reliability up to 5,000h at 105°C

Super High Capacitance Radial Lead Capacitor for Airbag Controller
LBK ▶ LBV series



Capacitance vs Case dimension : 25V

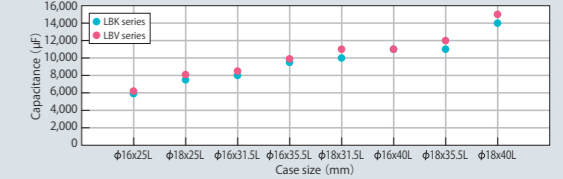

Capacitance vs Case dimension : 35V

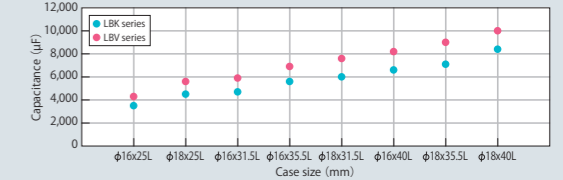

Dimensions (mm)

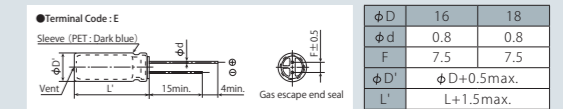

提案3 アルミ電解コンデンサ ALUMINUM ELECTROLYTIC CAPACITORS

Alchip™ MZS series AEC-Q200

Specifications

- SMD Capacitor $\phi 8 \times 10L \sim \phi 10 \times 10L$
- Voltage: 25 & 35V, Cap: 330 ~ 1,000 μF
- High reliability up to 2,000h at 105°C
- Downsizing and Lower ESR
- Vibration resistance structure (as needed)

Downsizing and Lower ESR SMD Capacitor for Control Circuit
MZR ▶ MZS series



Frequency Characteristics MZS35V680 $\mu F \phi 10 \times 10L$

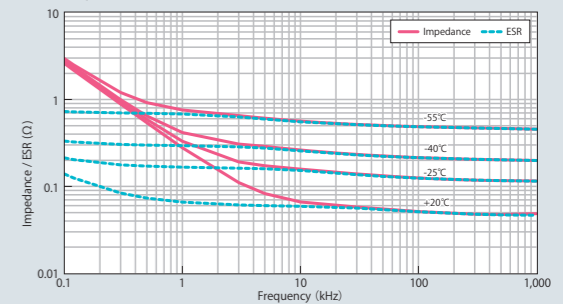

Dimensions (mm)

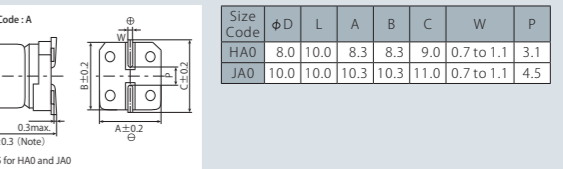

提案4 アルミ電解コンデンサ ALUMINUM ELECTROLYTIC CAPACITORS

Alchip™ MZL series AEC-Q200

Specifications

- SMD Capacitor $\phi 8 \times 10L \sim \phi 10 \times 10L$
- Voltage: 6.3 ~ 50V, Cap: 100 ~ 1,500 μF
- High reliability 105°C 5,000h
- Vibration resistance structure (as needed)

Low ESR and High Capacitance SMD Capacitor for ECU
MZA ▶ MZL series



Frequency Characteristics MZL 35V560 $\mu F \phi 10 \times 10L$

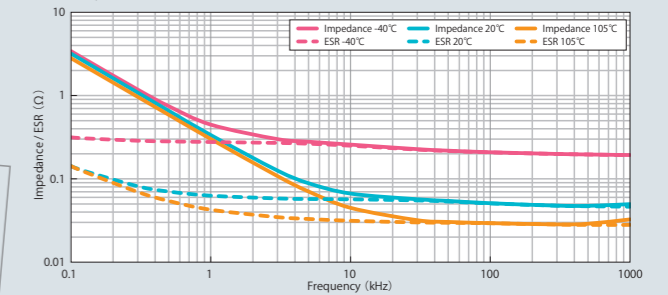

Dimensions (mm)

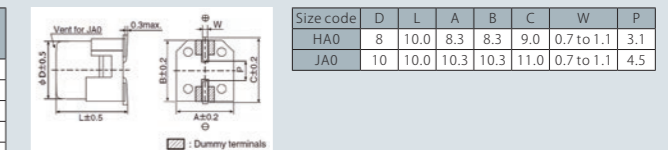

Recommended Standard Ratings

Rated Voltage (Vdc)	Cap (μF)	Size Code	ESR (Ω max./20°C, 100kHz)	Rated ripple current (mArms/105°C, 100kHz)	Part No.
25	470	HA0	0.08	850	EMZL250□RA471MHA0G
	820	JA0	0.06	1,190	EMZL250□RA821MJA0G
35	330	HA0	0.08	850	EMZL350□RA331MHA0G
	560	JA0	0.06	1,190	EMZL350□RA561MJA0G
50	100	HA0	0.34	350	EMZL500□RA101MHA0G
	220	JA0	0.18	670	EMZL500□RA221MJA0G

変える For Electric Drive System (HEV, EV)

コンデンサ(アルミ電解、電子回路用フィルム、積層セラミック)
Capacitors (Aluminum Electrolytic, Film, Multilayer Ceramic)

各種電動車両のパワーエレクトロニクス等に最適
Best for Driving Inverter, DC / DC Converter

インバータ主回路例と推奨部品 Example of Main Inverter Circuit and Recommended Products

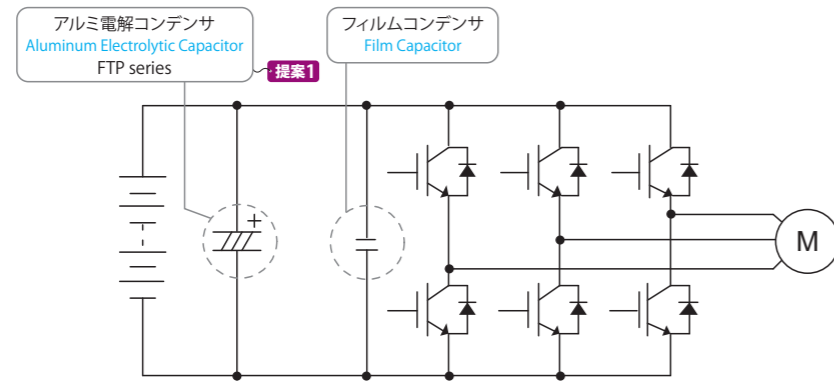

DC / DC コンバータ主回路例と推奨部品 Example of Main DC / DC Converter Circuit and Recommended Products

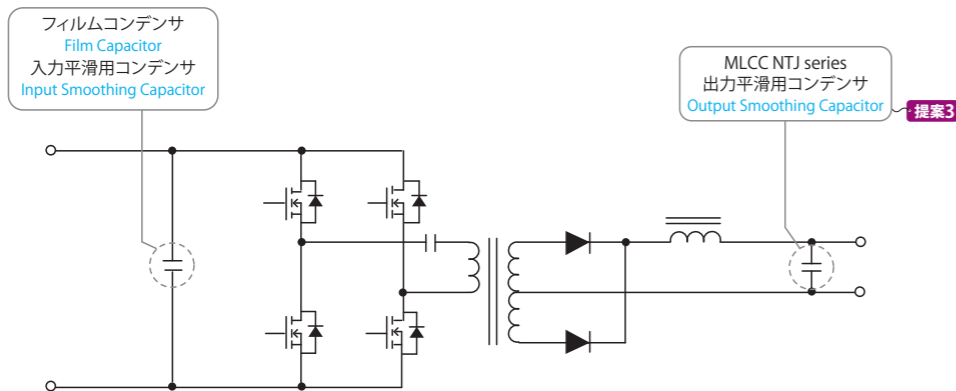

アイドリングストップ用 DC / DC コンバータ主回路例と推奨部品 Example of Main DC / DC Converter Circuit and Recommended Products for Start / Stop System

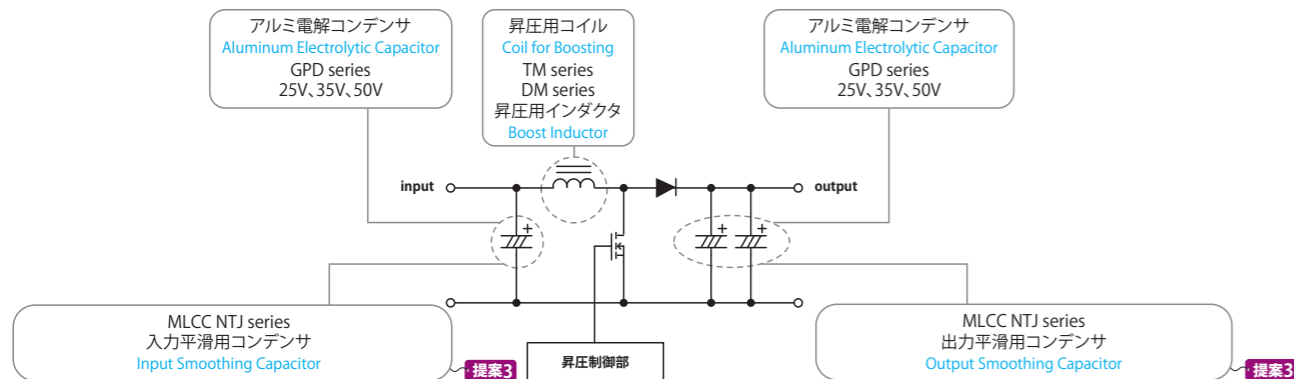

提案1 アルミ電解コンデンサ ALUMINUM ELECTROLYTIC CAPACITORS

FTP series

Specifications

- Screw Mount Terminal Capacitor 26x70x50 ~ 35x64x95
- Voltage: 63~450V, Cap: 270~21,000 μ F
- High reliability up to 5,000h at 85°C
- Super high ripple current capability for EV and Hybrid Inverter
- Improve space factor by Ellipse shape



Super High Ripple Current
Ellipse Shape Capacitor
FTP series for HEV Inverter

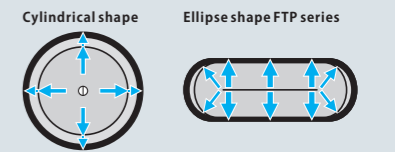

Ellipse shape and low profile structure make greater contact with the can. Greatly improved heat dissipation compared with cylindrical shape.

Dimensions (mm)

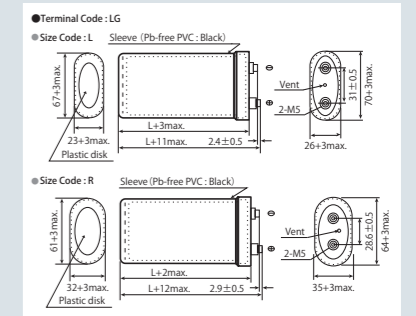

Recommended Standard Rating (450V)

Rated Voltage (Vdc)	Cap (μ F)	Case Size H x W x L (mm)	Dissipation Factor (tan δ)	Rated Ripple Current (Arms/85°C, 10kHz)	Part No.
450	270	26 x 70 x 50	0.25	10.1	EFTP451LGN271ML50M
	540	26 x 70 x 75	0.25	15.0	EFTP451LGN541ML75M
	760	26 x 70 x 95	0.25	18.0	EFTP451LGN761ML95M
	330	35 x 64 x 50	0.25	11.4	EFTP451LGN331MR50M
	660	35 x 64 x 75	0.25	16.7	EFTP451LGN661MR75M
930	35 x 64 x 95	0.25	20.1	EFTP451LGN931MR95M	

提案2 ナノ結晶合金コア NANOCRYSTALLINE CORES

FL series

Features

- ナノ結晶軟磁性合金を使用した高透磁率コア
- 少数巻で大きなインピーダンスが取れる
- 温度特性に優れる
- 絶縁種B種、難燃性 UL94V-0
- The high permeability core is made of nanocrystalline soft magnetic alloy
- High impedance in spite of a small number of turns
- Excellent temperature characteristics
- Conforming to insulating type B and incombustibility UL94V-0

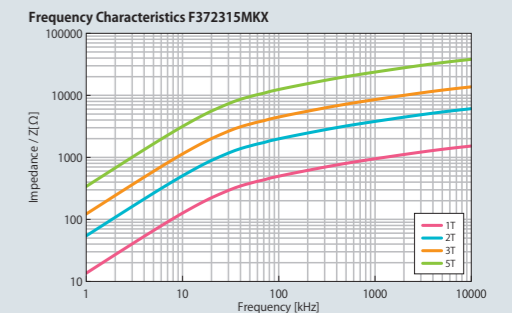
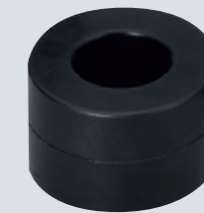

Recommended Standard Rating

Core Part No.	Cross Sectional Area cm ²	Magnetic Path Length cm	Weight g	Outside Dimensions			Inductance Coefficient (AL Value)	
				ϕ D [mm]	ϕ d [mm]	H [mm]	[μ H / N ² / 10kHz]	[μ H / N ² / 100kHz]
LRF251510MKCX	0.41	6.38	21	28.3	12.7	12.3	55.2	25.2
LRF251515MKCX	0.63	6.38	32	28.3	12.7	17.5	80.0	38.1
LRF322015MKCX	0.69	8.09	60	35.2	17.5	17.3	72.5	33.1
LRF372315MKCX	0.83	9.33	80	40.5	19.5	18.0	67.5	34.7

Dimensions

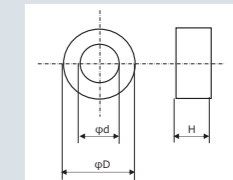

提案3 積層セラミックコンデンサ MULTILAYER CERAMIC CAPACITORS

NTD series

Features

- 温度特性はX7R特性
- 小形大容量で許容リプル電流が大きい
- 優れたノイズ吸収性能
- Temperature characteristic is X7R in EIA code
- Large capacitance by small size
- High permissible ripple current capability
- Excellent noise absorption

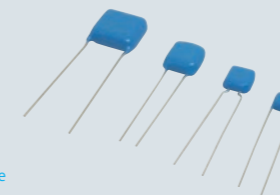

Recommended Standard Rating

Rated Voltage (Vdc)	Cap (μ F)	Part No.
25	33	KTD250B336M5A0T00
35	22	KTD350B226M5A0T00
50	15	KTD500B156M5A0T00
100	6.8	KTD101B685M5A0T00

NTJ series

表面実装金属キャップ形
Surface mount device (Metal cap type)

Recommended Standard Rating

Rated Voltage (Vdc)	Cap (μ F)	Part No.
25	68	KTJ250B686M55BF00
35	47	KTJ350B476M55BF00
50	33	KTJ500B336M55BF00
100	10	KTJ101B106M55BF00

NTF series

温度サイクル1,000サイクル保証
Heat Cycle 1,000 cycles

Recommended Standard Rating

Rated Voltage (Vdc)	Cap (μ F)	Part No.
25	33	KTF250B336M55NHT00
35	22	KTF350B226M55NHT00
50	15	KTF500B156M55NHT00
100	6.8	KTF101B685M55FHT00

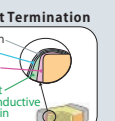

変える For On-Board Battery Charger Use

アルミ電解コンデンサ、
バリスタTNR™、チョークコイル
Aluminum Electrolytic Capacitors,
Metal Oxide Varistors TNR™, Choke Coils

プラグイン電動車両向け車載充電器等に最適
Best for Plug-In Vehicle

車載充電器主回路例と推奨部品 Example of Main On-Board Battery Charger Circuit and Recommended Products

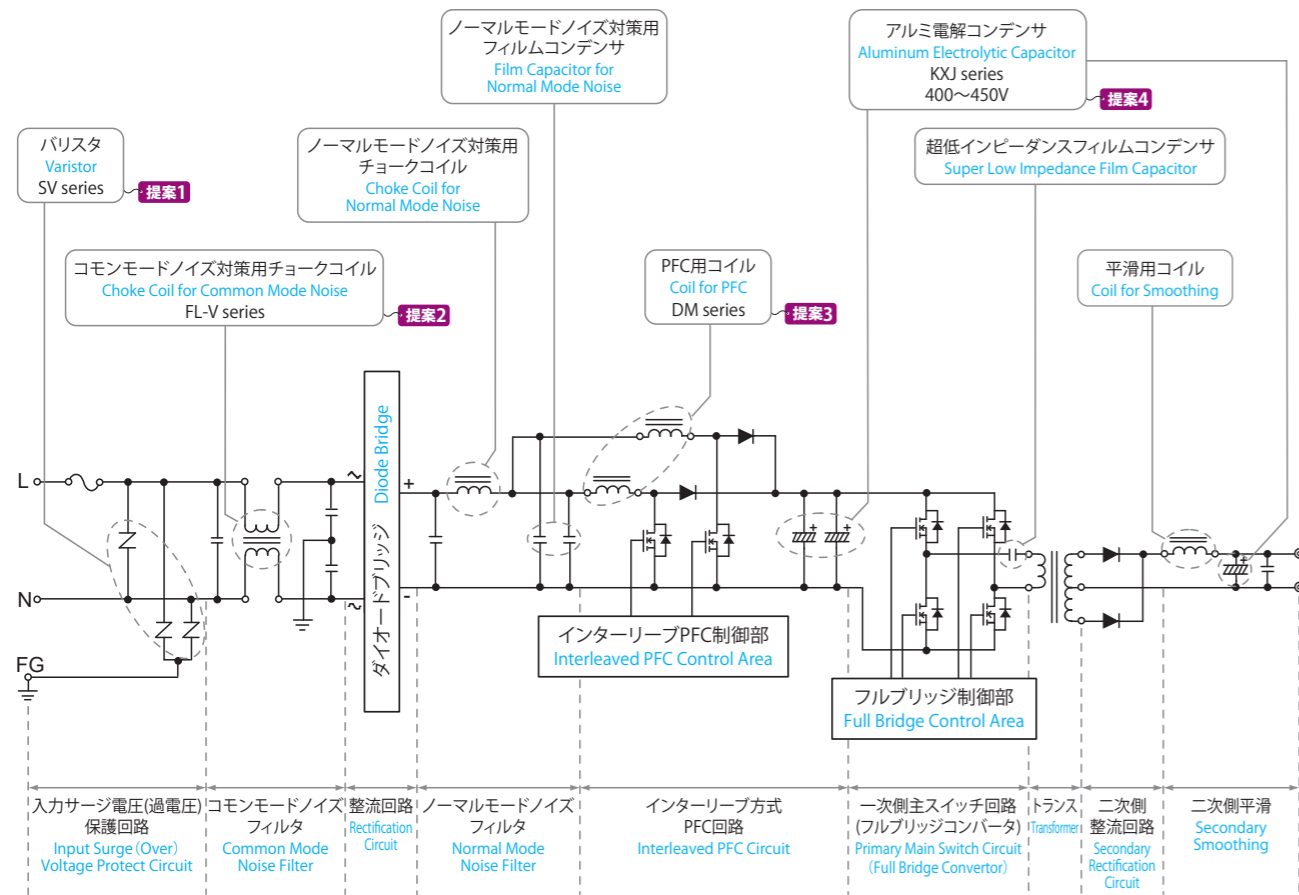

提案1 セラミックバリスタ METAL OXIDE VARISTORS

SV series Upgrade

Features

- 過電圧印加によるバリスタ破壊時に、外装樹脂の燃焼と飛散を抑制
- 耐候的性能を向上 (Upgrade)
 - 高温負荷: 125°C, 1,000時間
 - 耐湿負荷: 85°C 85% RH, 1,000時間
 - 温度サイクル: -40°C ⇄ +125°C, 1,000サイクル
- 外装の難燃度は高く、JIS, UL 規格等の接炎試験では着火しない (UL 規格では炎を離してから15秒以内に自己消火すること)
- 外装樹脂材料: UL94V-0の難燃性樹脂 (ハロゲンフリー) を採用
- AEC-Q200対応 (サイズ: φ10~14, バリスタ電圧: 220~680V)
- UL, CSA, VDE 認定品
 - UL1449 3rd File: E323623
 - CSA File: LR97864
 - VDE File: 118623
 - CQC File: 品番により異なります。弊社へお問合せください。
- 安全規格によって認証されている温度が異なります。詳細はお問合せください。
- Little scatter at the destruction under over voltage.
- Environmental characteristics (Upgrade)
 - High temperature operating: 125°C, 1,000h
 - Damp heat operating: 85°C 85% RH, 1,000h
 - Temperature cycle: -40°C ⇄ +125°C, 1,000cycles
- Coating resin doesn't burn under the flammability test of UL.
- Material of Coating resin: UL94V-0 and Halogen free



Non-flammable coated: SV series (Silicon resin coated)



Part No.	Maximum Ratings				Rated Wattage (W)	Max. Clamping Voltage (V)	Varistor Voltage V1mA (V)
	Max. Allowable Voltage S (Vrms)	Max. Allowable Voltage DC (V)	Max. Peak Current 8/20 μs (A)	Max. Energy 2ms (J)			
TND10SV471KTLBPA0	300	385	3,500A/1time, 2,500A/2times	60	0.4	25	775 470 (423~517)
TND10SV471KTLBPSA0	300	385	3,500A/1time, 2,500A/2times	60	0.4	25	775 470 (423~517)
TND10SV621KTLBPA0	385	505	3,500A/1time, 2,500A/2times	67	0.4	25	1025 620 (558~682)
TND10SV621KTLBPSA0	385	505	3,500A/1time, 2,500A/2times	67	0.4	25	1025 620 (558~682)
TND12SV471KTLBPA0	300	385	4,200A/1time, 3,000A/2times	60	0.4	25	775 470 (423~517)
TND12SV621KTLBPA0	385	505	4,200A/1time, 3,000A/2times	67	0.4	25	1025 620 (558~682)
TND14SV471KTLBPA0	300	385	6,000A/1time, 5,000A/2times	125	0.6	50	775 470 (423~517)
TND14SV621KTLBPA0	385	505	5,000A/1time, 4,500A/2times	136	0.6	50	1025 620 (558~682)
TND20SV471K800AA0	300	385	10,000A/1time, 7,000A/2times	250	1.0	100	775 470 (423~517)
TND20SV621K800AA0	385	505	7,500A/1time, 6,500A/2times	273	1.0	100	1025 620 (558~682)

提案2 ナノ結晶合金コモンモードコイル NANOCRYSTALLINE COILS

FL-V series

Features

- 従来コイルに比べ、高性能、小型
- 最大定格電圧は、480/700Vに対応
- 使用温度範囲: -40~130°C (自己発熱含む)
 - Compared to conventional coils, high performance, small
 - Maximum rated voltage is compatible with 480/700V
 - Operating temperature range including self-heating: -40 to 130 degrees C

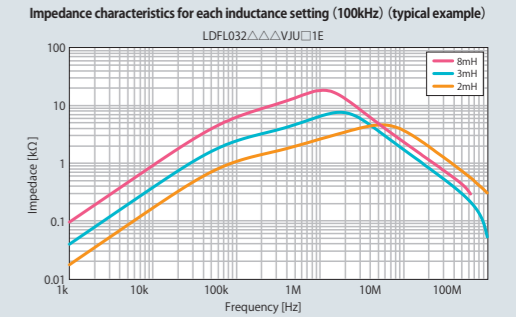
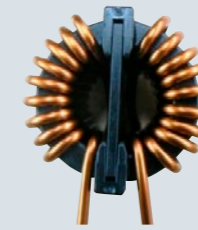

Recommended Standard Rating

Mounting location	rated current [A]	Core Part No.	Coil Parts No.	outside dimensions [mm]			Inductance setting area (100kHz)		
				D	H	W	Without radiation	With radiation	With radiation
Input side	32	LRF312115MCX	LDFL032△△△V22□1E	43.0	43.0	32.0	1mH	5mH	10mH
			LDFL032△△△VJU□1E	50.0	51.0	35.5			
Output side	25	LRF312115MCX	LDFL025△△△V8□1E	38.0	38.0	32.0			
			LDFL025△△△V22□1E	43.0	43.0	32.0			

△ Of the coil number shows rated inductance, and □ shows the shape.

Dimensions

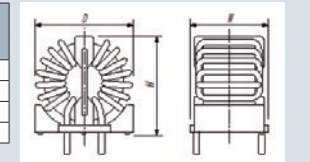

提案3 ダストチョークコイル DUST CHOKE COILS

DM series

Features

- フェライトに比べて、飽和磁束密度が高いため、直流重畳特性が良く、小形化できます
- 周波数特性、温度特性に優れています
- 使用温度範囲: -40~130°C (UL94V-0 B種)
 - Miniaturization and excellent D.C. bias characteristics in comparison with sendust coils by the feature of higher saturation magnetic flux density.
 - Excellent characteristics in frequency and temperature.
 - Operating temperature range: -40~130°C (UL94V-0 Class B)



Dimensions

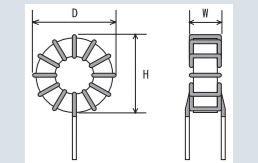

Representation Rating

Part No.	Rated Current (A)	Inductance (μH) at 100kHz		D.C.R. (mΩ)	Outside Dimensions (mm)		
		300 (0A)	200 (15A)		φD	H	W
LHDM015201DXHV1E	15	300 (0A)	200 (15A)	39max.	47max.	46max.	29max.
LHDM015251DYBV1E	15	340 (0A)	250 (15A)	34max.	51max.	50max.	29max.
LHDM020201DZBV1E	20	250 (0A)	200 (20A)	22max.	59max.	58max.	31max.
LHDM025151DZBV1E	25	200 (0A)	150 (25A)	17max.	59max.	58max.	31max.

* 台座につきましては、別途お問い合わせ下さい。 Please ask separately about a pedestal.
* コイル両端電圧が500Vを超える場合は、別途お問い合わせ下さい。 When voltage across the two ends of the coil exceeds 500V, please ask for information separately

D.C Bias Characteristics (Example) at 100kHz

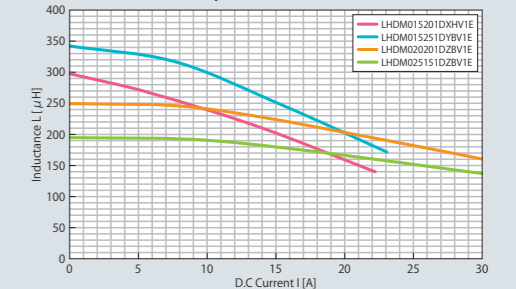

提案4 アルミ電解コンデンサ ALUMINUM ELECTROLYTIC CAPACITORS

KXJ series AEC-Q200

Specifications

- Radial Lead Capacitor φ10x16L~φ18x50L
- Voltage: 160~500V, Cap: 6.8~680 μF.
- Super compact high voltage capacitor.
- High reliability up to 8,000~12,000h at 105°C.

Compact High Voltage, Longer Life Radial Lead Capacitor
KXJ series for On-Board Charger



Recommended Standard Rating (400, 450V)

Rated Voltage (Vdc)	Cap (μF)	Case Size φD × L (mm)	Dissipation Factor (tan δ)	Rated Ripple Current (mArms/105°C, 120Hz)	Part No.
400	120	18 x 35.5	0.24	870	EKXJ401E LL 121MMMP1S
	150	18 x 40	0.24	985	EKXJ401E LL 151MM40S
	220	18 x 50	0.24	1,220	EKXJ401E LL 221MM50S
450	100	18 x 35.5	0.24	835	EKXJ451E LL 101MMP1S
	120	18 x 40	0.24	930	EKXJ451E LL 121MM40S
500	150	18 x 50	0.24	1,060	EKXJ451E LL 151MM50S

Please refer to the catalog.

LL: for lead forming or taping code.

Dimensions (mm)

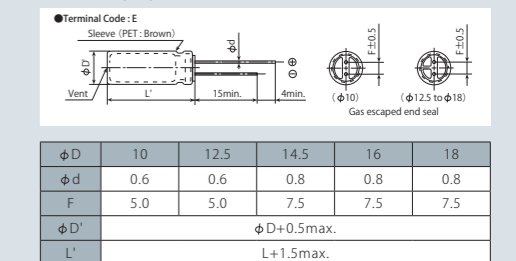

φD	10	12.5	14.5	16	18
φd	0.6	0.6	0.8	0.8	0.8
F	5.0	5.0	7.5	7.5	7.5
φD'	φD+0.5max.				
L'	L+1.5max.				

蓄える For Storage Use

電気二重層キャパシタ DLCAP™
Electric Double Layer Capacitors DLCAP™

電装システムのバックアップ等のバッテリーアシストなどに最適
Best for Battery Assist Use, backup of electrical system.

提案1 DLCAP™ リードタイプ DLCAP™ Lead Type

業界トップクラスの低抵抗
優れた低温特性
Low resistance of the industry's top class.
Excellent low temperature characteristics.

DKA series

Rated voltage: 2.5V
Operating temperature: -40°C ~ +70°C

Specification	φ16 × 25L	φ18 × 35L	φ18 × 50L
Capacitance (Typ.)	14F	30F	50F
DCIR (Typ.)	26.0mΩ	17.0mΩ	11.0mΩ
Sample	Available	Available	Available

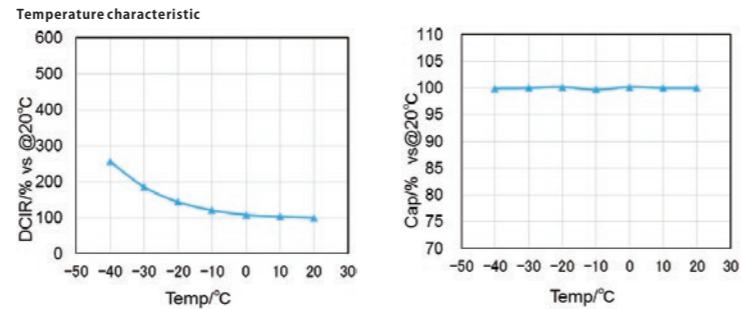

アプリケーション例 Expected Application

パワーバックアップ
Power Backup

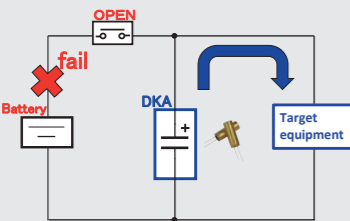

ピークアシスト (並列)
Peak Assist (parallel)

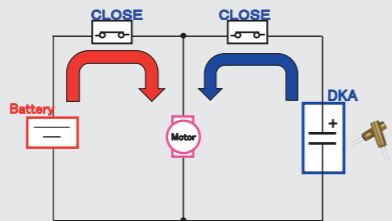

ピークアシスト (直列)
Peak Assist (series)

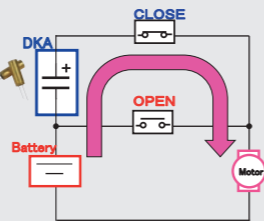

- 自動ドアロック解除、eCall、X-by-wire など、バッテリー喪失時のバックアップ電源として
- 比較的大きい電流を短時間必要とする小型アクチュエーターなどの電源として
- Backup power supply for automatic door lock release, eCall and X-by-wire.
- Applications requiring a relatively large current for a short time such as driving small actuators.

評価モジュール (パワーバックアップ) Evaluation module (Power backup)

ブロック図
Block Diagram

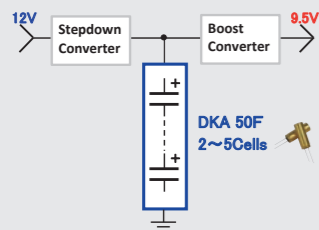

特性
Characteristics

Items	Specs
Input voltage	16V (MAX)
Charge current	0.5~1A
Standby current	0.1A (MAX)
Output voltage	9~12V
Output current	20A (MAX)
Energy capacity	180~450Ws

*スペックは、変更される場合があります。
Specs are subject to change.

外観
Appearance

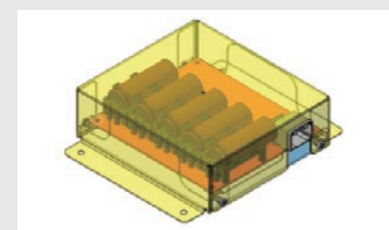

- 入出力コンバーター内蔵で、直ぐに動作評価可能です。
- 必要エネルギー量にあわせ、セルを2~5本まで設定可能です。
- This module has a built-in input/output converter, so you can immediately evaluate.
- Two to five cells can be set according to the required energy.

*掲載モジュールはあくまで「提案イメージ」であり、実際にご検討の際には別途個別打ち合わせが必要です。
The above is for reference only and the actual use must be checked separately.

*本機構流用に関わるあらゆる特許につきましては、お客様の責任にてご検討、確認をお願い致します。
Please check with your own all the patents on this product.

提案2 DLCAP™

DXE series

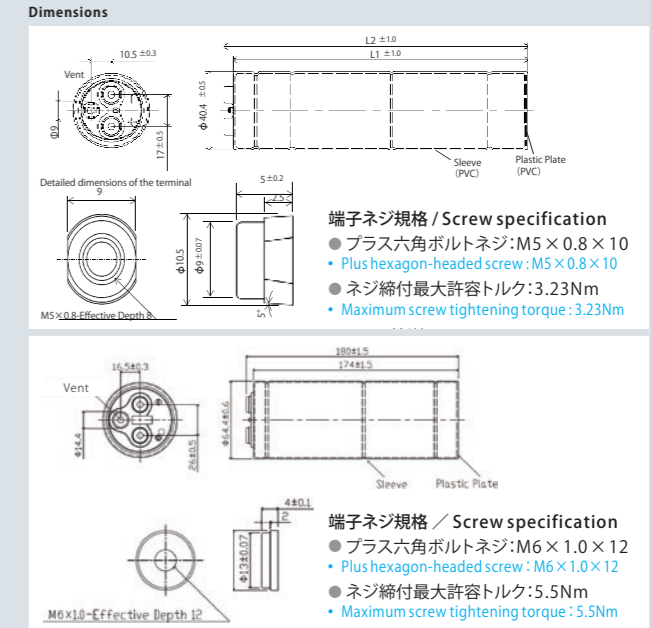

Features

- 内部抵抗値50%以上の低減(当社従来比)
- 耐熱70°Cの保証
- Internal Resistance reduction by 50% or more (of that of conventional company products)
- 70°C High temperature type

Automotive applications

- 減速エネルギー回生
- 電装機器電力安定化
- アイドリングストップ時パワーアシスト
- Braking Energy Recuperation
- Power stabilization for electric devices
- Power assist at idling stop

DXE series Spec

Rated Voltage 2.5V Operating Temperature Range -40°C~+70°C	DXE series				
	φ40 × 65L	φ40 × 105L	φ40 × 150L	φ40 × 150L	φ63.5 × 172L
Capacitance @ +20°C (Typ. (rated))	400F	800F	1,200F	1,400F	3,600F
DCIR @ +20°C (Typ.)	2.1mΩ	1.1mΩ	0.8mΩ	1.1mΩ	0.27mΩ
Energy Storage (Rated)	0.4Wh	0.7Wh	1.1Wh	1.3Wh	3.2Wh

提案3 DLCAP™ 次世代シリーズ DLCAP™ Next Generation Series

車載市場よりご要望の高い「省スペース化」、「エンジンルーム搭載」、「コールドスタート」に対応するため、独自の技術で高耐電圧、広温度範囲を実現。
Achieved high rated voltage and wide temperature range with our own technology to meet the needs from automotive market such as "space saving", "mounted in an engine room", and "cold start".

DXF series



Features

- 耐電圧を2.5V⇒2.8Vに性能アップ
- 温度遅延により3.0V(-40°C~+50°C)で使用可能
- Rated voltage 2.5V⇒2.8V.
- It can be used at 3.0V(-40~+50°C) by temperature delay.

DXF series Spec

Operating Temperature Range -40°C~+60°C	DXF series
	φ63.5X172L
Rated Voltage	2.8V
Capacitance @ +20°C (Min. (rated))	3150F
DCIR @ +20°C (Typ.)	0.3mΩ
Energy Storage (Rated)	3.5Wh

【蓄電デバイス低温特性(当社独自比較)】

Power storage device low-temperature characteristics (independent survey of Nippon Chemi-Con)

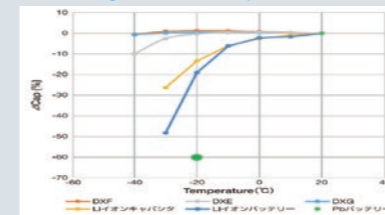

DXG series

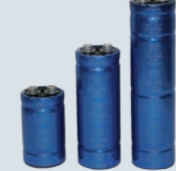

Features

- 低温特性改善。
- カテゴリ温度範囲70°C⇒85°Cに性能UP。
- Low-temperature characteristics improvement.
- Temperature range improved from 70°C⇒85°C

DXG series Spec

Rated Voltage 2.5V	DXG series		
	φ40 × 65L	φ40 × 105L	φ40 × 150L
Operating temperature range	-40°C~+85°C		
Capacitance @ +20°C (Min. (rated))	300F	590F	910F
DCIR @ +20°C (Typ.)	1.2mΩ	0.7mΩ	0.5mΩ
Energy Storage (Rated)	0.3Wh	0.6Wh	0.8Wh

提案4 DLCAP™ モジュール DLCAP™ Module

標準モジュール
Standard Module

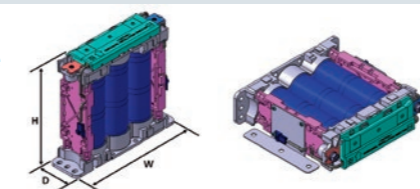

接続例
Connecting Example

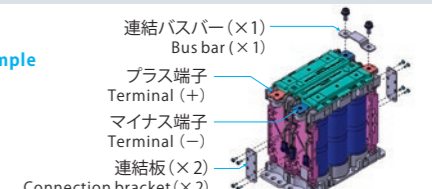

Features

- 電圧バランス回路、過電圧検知回路内蔵
- 温度モニター用サーミスタ内蔵
- 本製品を複数台直列接続して使う場合は、最大8直列までとして下さい。それ以上直列接続される場合は、弊社までお問い合わせ下さい。
- Built-in voltage balance circuit, failure detection circuit
- Built-in thermistor for temperature monitor
- Please consult us if these items are needed to be connected more than 8 in series.

*ご希望により特殊仕様のモジュール設計にも対応いたします。
Special designs are available on requests.

Module Spec

Rated Voltage [V]	Capacitance [F]	Case Size	Internal Resistance		Weight [kg]	Energy Storage [Wh]	Part No.		
			Typ. [mΩ]	Max. [mΩ]					
7.5	133	113	97	6.6	0.7	1.0	MDXE7R5S1315B3111B		
	466	396	54	180	173	3.6	4.2	1.2	3.7

*1 参考値 / Reference data